

experience

function

quality

style

technology

effective 6 august 2012 V2

# retail price catalogue





## Purchase Orders

- Please fax or email purchase orders to priority number or address listed below.
- Phone orders are not accepted.
- We require that each purchase order include: a purchase order number, Con-Serv product code, quantity required, store details, contact number and minimum order value freight charge if applicable.
- Project purchases - refer to project quotations.
- Purchase orders direct to customers or secondary sites will incur an additional freight delivery charge - please see Delivery Services below.

## Freight Delivery Requirements

- Purchase orders valued at \$150 and more including GST are FREE INTO STORE.
- Purchase orders valued under \$150 including GST will incur a \$11.00 GST inclusive freight delivery charge.
- Please include the freight delivery charge with orders when applicable.
- ALL URGENT ORDERS requiring a PRIORITY DELIVERY will incur a freight delivery charge. Contact Con-Serv on priority phone number 1300 467 322 for a quotation. Please include the quotation amount on the purchase order.
- These freight delivery requirements will be held firm unless an unexpected or unusual freight cost increase occurs.

- In the event of there being any conflict between conditions of sale and conditions of purchase, or any other terms by the buyer, Con-Serv's conditions of sale will prevail unless otherwise agreed in writing.

**Priority Phone Number**

**1300 467 322**

**Priority Fax Number**

**1300 656 811**

**E-mail**

**mail@con-serv.com.au**

## Delivery Services

- As Con-Serv products are made to order, delivery will be subject to Con-Serv's production schedule. We endeavour to despatch goods within 48 hours of receipt of order.
- Purchase orders weighted under 5 kg will be despatched via Express Service.
- Purchase orders weighted over 5 kg will be despatched via OFF PEAK Road Express Service. Refer to OFF PEAK delivery schedule.
- Purchase orders required for delivery to secondary sites will incur an additional freight delivery charge. Contact Con-Serv on priority phone number 1300 467 322 for a quotation. Please include the quotation amount on the purchase order.

## OFF PEAK Delivery Schedule

- |                         |                |                   |                |  |                |
|-------------------------|----------------|-------------------|----------------|--|----------------|
| • South East Queensland | 2 working days | • Victoria        | 3 working days | • Western Australia                    | 7 working days |
| • Rest of Queensland    | 3 working days | • South Australia | 4 working days | • Northern Territory                   | 7 working days |
| • New South Wales       | 3 working days | • Tasmania        | 4 working days | • <b>Not a time guarantee service.</b> |                |

## Project Quotations

- Con-Serv will offer preferential pricing for project quotations and commercial quantities.
- Any reductions, variations or split deliveries will require a delivery charge. Please contact Con-Serv for a quotation.
- Project quotations will only be held until the expiry date outlined on the quotation.
- Project purchases must include the quotation number.

## Stock Returns

- For store purchasing errors, customer changes and cancellations, including specified project item(s) returns, a 15% stock return fee will apply on the net value of the returned item(s). The stock return fee will be waived should the item(s) be returned at the expense of the purchaser, within 28 days of stock receipt date.
- All returned goods must be undamaged and in original condition.
- Custom made items are non returnable.
- Item(s) not returned within 12 months of purchase date will not be considered for credit.

## Credits

- Credits will not be approved without an authorisation number from Con-Serv head office.
- Credits are only subject for approval once item(s) have been inspected upon return.
- Credit authorisations will be cancelled if the item(s) are not returned within 90 days of authorisation.

## Our Promise

Con-Serv Corporation Australia Pty Ltd warrants all products to be free from manufacturing defects for 5 years from date of purchase. Con-Serv will repair or replace defective items if defects occur in normal use. Con-Serv will not be liable for defects arising through normal wear and tear. Item(s) must be returned with proof of purchase to Con-Serv at 17 Glentanna Street, Kedron, Queensland 4031. We will attend to your warranty claim after we make appropriate investigations. Contact our Service Manager during normal office hours on 1300 467 322 or at our email address of [warranty@con-serv.com.au](mailto:warranty@con-serv.com.au). If a warranty claim is accepted, Con-Serv will bear the reasonable costs of the return of the defective item(s) to us. A claim for expenses associated with making a claim for a defective product must be in writing and submitted to us with copies of supporting documents. The benefits given under our warranty are in addition to other rights and remedies of the customer under a law in relation to goods and services to which this warranty relates. Our goods come with guarantees that cannot be excluded under the Australian Consumer Law. You are entitled to a replacement or a refund for a major failure and compensation for any other reasonable foreseeable loss or damage. You are also entitled to have the goods repaired or replaced if the goods fail to be of acceptable quality and the failure does not amount to a major failure.



## Bathrooms

Bathroom Accessories - Modena Collection .....	2-3
Bathroom Accessories - Comfort Collection .....	4-7
Bathroom Baskets .....	8
Bathroom Rails - 25 mm Comfort Collection .....	9
Handheld Showers .....	20-31
Overhead Showers .....	10-17
Vandal & Tamper Proof Showers .....	18

## Shower Parts and Accessories

Arms and Flanges .....	38-39
Elbows and Brackets .....	35
Diverter .....	37
Handpieces .....	34
Handpieces - Streamjet™ Mix and Match Options .....	19
Shower Hoses, Attachments and Repair Kit .....	32-33
Slide-Rail Options .....	36
Spare Parts and Accessories .....	45

## Flow Valves

Aerators - Domestic & Anti-Vandal .....	40-41
Flow Regulated Valves & Flood Stop Valve .....	42
Flow Regulated Isolating Ball Valves & Dual Check .....	43
Meter-Beater® - Flow Regulator for Screw Down Taps .....	44

## Shower Systems For Healthcare Applications

HOSFAB® - Commercial Healthcare Kits .....	50-53
HOSFAB® - Standard Healthcare Kits .....	54-57
HOSFAB® - Premium Healthcare Kits .....	58-61
HOSFAB® - People With Disabilities (PWD) Kits .....	48-49
Healthcare Kit Accessories .....	62









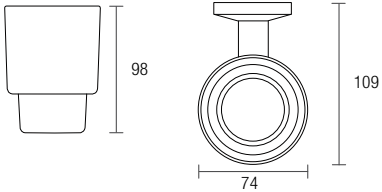

## Grab Rails

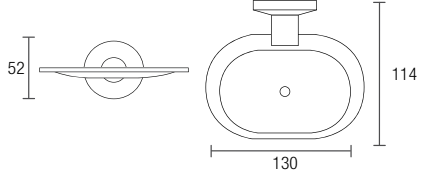
SAFE-ASSIST® - Regular - Straight Grab Rails .....	66-67
SAFE-ASSIST® - Regular - Toilet Assist Grab Rails .....	68-69
SAFE-ASSIST® - Regular - Corner Grab Rails .....	70
SAFE-ASSIST® - Regular - Shower Recess Grab Rails .....	71
SAFE-ASSIST® - Premium - Straight Grab Rails .....	72-73
SAFE-ASSIST® - Premium - Toilet Assist Grab Rails .....	74-75
SAFE-ASSIST® - Premium - Corner Grab Rails .....	76
SAFE-ASSIST® - Premium - Shower Recess Grab Rails .....	77
SAFE-ASSIST® - Premium - Towel Rail / Grab Rail Combination .....	78
SAFE-ASSIST® - Premium - Linear Grab Rail Options .....	79
SAFE-ASSIST® - TILTLOCK® - Lock-Up / Lock-Down Folding Rail-Ways® .....	80
SAFE-ASSIST® - SWINGLOCK® - Side Swing Grab Rail .....	81
SAFE-ASSIST® - Folding Shower Seats .....	82-83
SAFE-ASSIST® - Backrest Toilet Support Options .....	84-85
SAFE-ASSIST® - Anti-Ligature Grab Rails .....	86-87
Rail-Ways® - Accessories .....	63

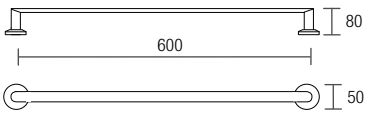

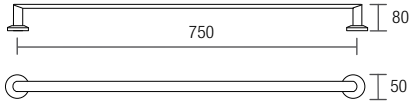

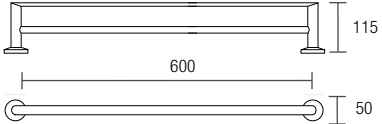

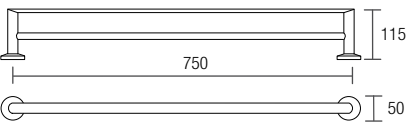

## Technical Product Information

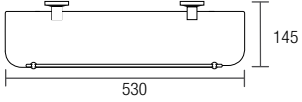

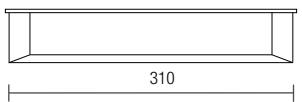

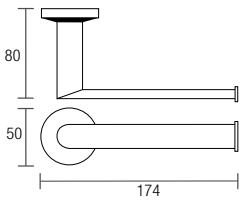

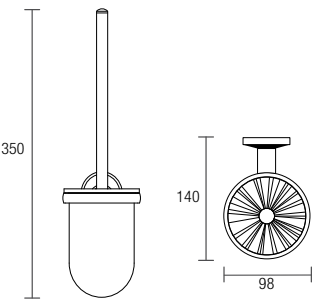

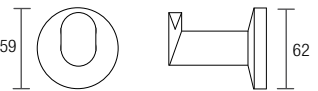

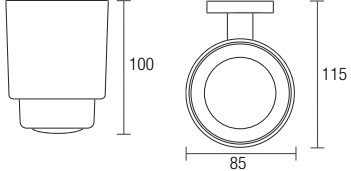
CLAM™ Flange Information Page .....	64
HYGIENIC SEAL® Information Page .....	65
Stainless Steel Information Page .....	88
Product Standards Index .....	89-96
Terms and Conditions of Sale .....	Inside back cover
Warranty .....	Inside front cover

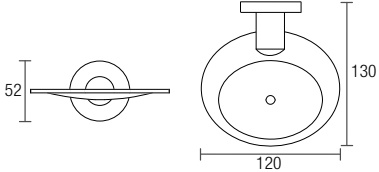

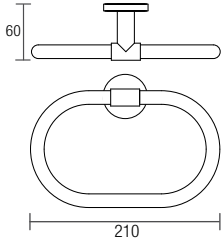

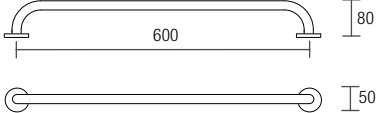

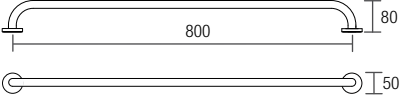

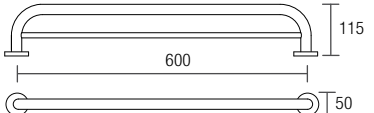

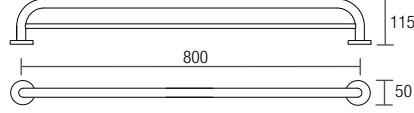

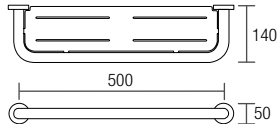

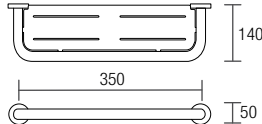

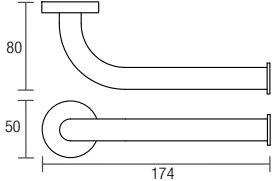

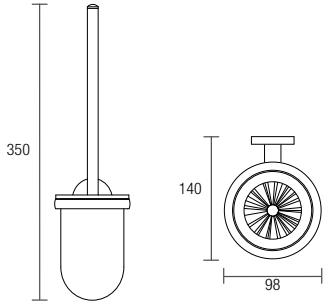

	Code	Finish	Without GST	With GST	Features
<b>BA 100 C - TUMBLER HOLDER</b>					
	BA 100 C	Chrome			Chrome plated brass. Frosted glass tumbler.
		Spare part			
	BA 700 GO	Glass only			
					
<b>BA 101 C - SOAP DISH HOLDER</b>					
	BA 101 C	Chrome			Chrome plated brass.
					
<b>BA 104 C - 600 mm - 20 mm SINGLE TOWEL RAIL</b>					
	BA 104 C	Chrome			600 mm $\emptyset$ to $\emptyset$ wall fixings. Chrome plated brass.
					
<b>BA 105 C - 750 mm - 20 mm SINGLE TOWEL RAIL</b>					
	BA 105 C	Chrome			750 mm $\emptyset$ to $\emptyset$ wall fixings. Chrome plated brass.
					
<b>BA 106 C - 600 mm - 20 mm DOUBLE TOWEL RAIL</b>					
	BA 106 C	Chrome			600 mm $\emptyset$ to $\emptyset$ wall fixings. Chrome plated brass.
					
<b>BA 107 C - 750 mm - 20 mm DOUBLE TOWEL RAIL</b>					
	BA 107 C	Chrome			750 mm $\emptyset$ to $\emptyset$ wall fixings. Chrome plated brass.
					

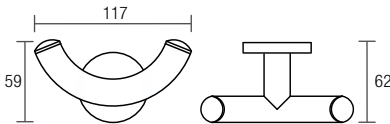

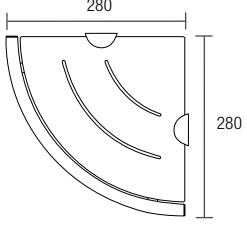

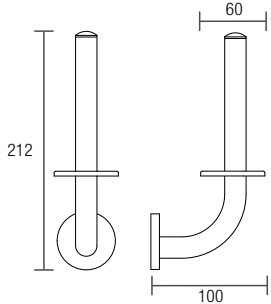

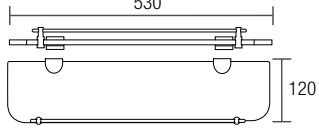

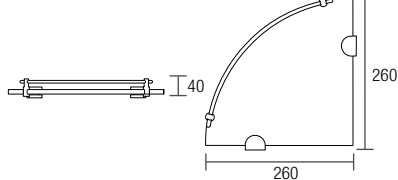

	Code	Finish	Without GST	With GST	Features
<b>BA 108 C - 530 mm X 10 mm CLEAR TEMPERED GLASS SHELF</b>					
	BA 108 C	Chrome			530 mm x 10 mm clear tempered glass shelf. Brackets chrome plated brass.
	BA 729 B0	Spare part Barrier only			
					
<b>BA 111 C - HAND TOWEL RAIL</b>					
	BA 111 C	Chrome			280 mm Ø to Ø wall fixings. Chrome plated brass.
					
<b>BA 112 C - PAPER HOLDER</b>					
	BA 112 C	Chrome			Chrome plated brass.
					
<b>BA 114 C - TOILET BRUSH WITH HOLDER</b>					
	BA 114 C	Chrome			Brass made wall mounted toilet brush set with frosted glass bowl.
					
<b>BA 115 C - SINGLE ROBE HOOK</b>					
	BA 115 C	Chrome			Chrome plated brass.
					

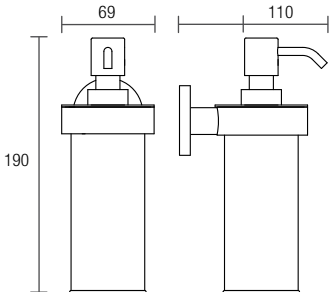
	Code	Finish	Without GST	With GST	Features
<b>BA 700 C - TUMBLER HOLDER</b>					
	BA 700 C	Chrome			Chrome plated brass. Frosted glass tumbler
	BA 700 GO	Glass only			
<b>BA 701 C - SOAP DISH HOLDER</b>					
	BA 701 C	Chrome			Chrome plated brass.
					
<b>BA 703 C - TOWEL RING</b>					
	BA 703 C	Chrome			Chrome plated brass.
					
<b>BA 704 C - 600 mm - 20 mm SINGLE TOWEL RAIL</b>					
	BA 704 C	Chrome			600 mm Ø to Ø wall flange.
					
<b>BA 705 C - 800 mm - 20 mm SINGLE TOWEL RAIL</b>					
	BA 705 C	Chrome			800 mm Ø to Ø wall flange.
					
<b>BA 706 C - 600 mm - 20 mm DOUBLE TOWEL RAIL</b>					
	BA 706 C	Chrome			600 mm Ø to Ø wall flange.
					

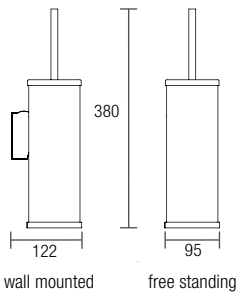
	Code	Finish	Without GST	With GST	Features
<b>BA 707 C - 800 mm - 20 mm DOUBLE TOWEL RAIL</b>					
	BA 707 C	Chrome			800 mm $\emptyset$ to $\emptyset$ wall fixings.
					
<b>BA 708 C - 500 mm - STAINLESS STEEL SHELF WITH 20 mm PROTECTIVE BARRIER</b>					
	BA 708 C	Polish Supreme			500 mm $\emptyset$ to $\emptyset$ wall fixings. Complies as per requirements of AS 1428.1-2009 section 15.4.2 (B2) Shelves. External to circulation space.
					 
<b>BA 710 C - 350 mm - STAINLESS STEEL SHELF WITH 20 mm PROTECTIVE BARRIER</b>					
	BA 710 C	Polish Supreme			350 mm $\emptyset$ to $\emptyset$ wall fixings. Complies as per requirements of AS 1428.1-2009 section 15.4.2 (B1) Shelves. Within circulation space.
					 
<b>BA 712 C - PAPER HOLDER</b>					
	BA 712 C	Chrome			Chrome plated brass.
					
<b>BA 714 C - TOILET BRUSH WITH HOLDER</b>					
	BA 714 C	Chrome			Brass made wall mounted toilet brush set with frosted glass bowl.
		Spare parts			
	BA 714 B0	Brush head only			
	BA 714 G0	Glass only			
	BA 714 BH	Handle only			
					

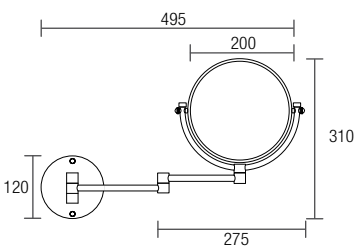

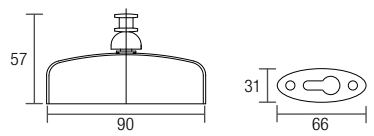

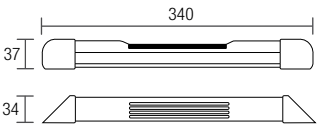





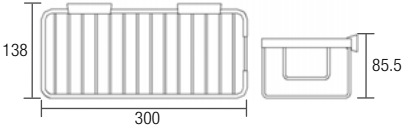

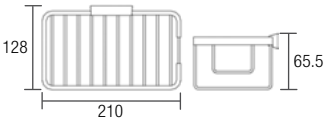

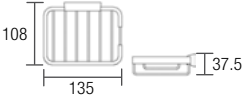

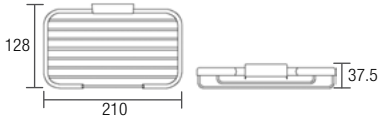

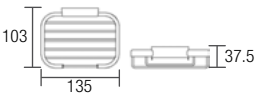
	Code	Finish	Without GST	With GST	Features
<b>BA 715 C - DOUBLE ROBE HOOK</b>					
	BA 715 C	Chrome			<p>Chrome plated brass.</p> 
<b>BA 718 C - STAINLESS STEEL CORNER SHELF WITH 20 mm PROTECTIVE BARRIER</b>					
	BA 718 C	Polish Supreme			<p>280 mm x 280 mm x 90° with floating mount brackets.</p> 
<b>BA 721 C - SPARE PAPER HOLDER</b>					
	BA 721 C	Chrome			<p>Chrome plated brass.</p> 
<b>BA 729 C - 530 mm x 10 mm GLASS VANITY SHELF</b>					
	BA 729 C	Chrome - with Barrier			<p>Brass made mounting brackets. 530 mm x 120 mm x 10 mm clear tempered glass shelf.</p> 
<b>BA 739 C - 260 mm x 10 mm GLASS CORNER SHELF</b>					
	BA 739 C	Chrome - with barrier			<p>260 mm radius, 10 mm clear tempered glass with brass integrated barrier rail and wall mounts.</p> 
		Spare parts			
	BA 739 B0	Barrier only			
	BA 769 C	Mount brackets - pair			

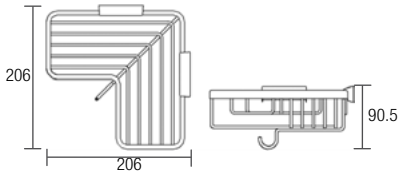

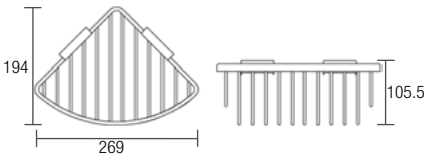
	Code	Finish	Without GST	With GST	Features
<b>BA 742 C - WALL MOUNTED SOAP DISPENSER</b>					
	BA 742 C	Chrome			Chrome plated brass. Wall mounted. 250 ml capacity. 
		Spare part			
	BA 742 DP	Dispenser pump			
<b>BA 750 C - TOILET BRUSH WITH HOLDER</b>					
  <p>wall mounted      free standing</p>	BA 750 C	Chrome			Brass made wall mounted and free standing toilet brush set with a plastic easy clean inner sleeve. Stainless steel fixing screws supplied. 
		Free standing			
	BA 751 C	Chrome			
	BA 714 B0	Brush head only			
<b>BA 780 C - DUAL SIDED MIRROR</b>					
	BA 780 C	Chrome			Chrome plated brass. Normal and 3x magnification. 
<b>BA 782 C - RETRACTABLE CLOTHES LINE</b>					
	BA 782 C	Chrome			Chrome plated brass. 2750 mm maximum cord extension. 
<b>BA 219 - SHOWER CUBICLE FOOT REST</b>					
	BA 219 C	Chrome			Stylish, fully moulded Polycarbonate/ABS corner footrest with concealed fixings for shower recess. Supplied with 1½" x 10G stainless steel screws and wall plugs. 
	BA 219 WT	White			
	BA 219 WTC	White/Chrome			
	BA 219 WTG	White Gold			
	BA 219 SC	Satin Completely			
	BA 219 CG	Chrome Gold			
	BA 219 G	Gold			
<p>Must be fitted to a solid wall or other firm surface. <b>MAX 85 KILOS LOAD BEARING</b></p>					

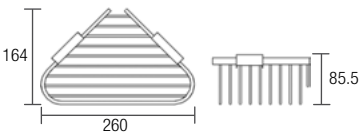
# BATHROOM BASKETS - COMFORT COLLECTION

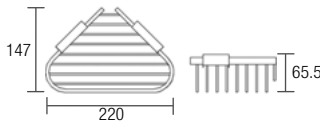

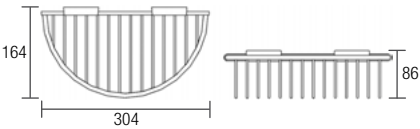







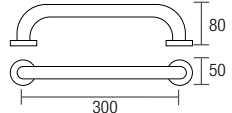

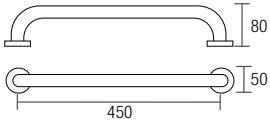
Select from a range of various depths, rectangle, corner and semi-circular wire basket designs that display strength and creative excellence. Constructed of heavy chrome plated brass. All baskets have innovative concealed fixings.

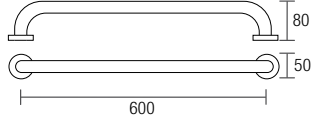

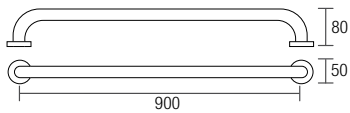

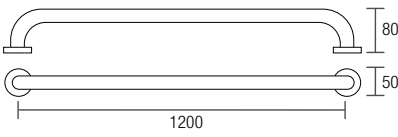

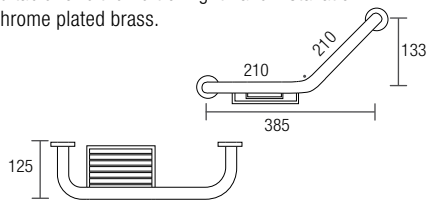
	Code	Finish	Without GST	With GST	Features
<b>WB 001 - RECTANGULAR BASKET - LARGE</b>					
	WB 001 C	Chrome			
	WB 001 CG	Chrome/Gold			
<b>WB 002 - RECTANGULAR BASKET - MEDIUM</b>					
	WB 002 C	Chrome			
	WB 002 CG	Chrome/Gold			
<b>WB 003 - RECTANGULAR BASKET - SMALL</b>					
	WB 003 C	Chrome			
	WB 003 CG	Chrome/Gold			
<b>WB 004 - OPEN FRONT RECTANGULAR BASKET - MEDIUM</b>					
	WB 004 C	Chrome			
	WB 004 CG	Chrome/Gold			
<b>WB 005 - OPEN FRONT RECTANGULAR BASKET - SMALL</b>					
	WB 005 C	Chrome			
	WB 005 CG	Chrome/Gold			
<b>WB 006 - CORNER BASKET WITH HOOK</b>					
	WB 006 C	Chrome			
	WB 006 CG	Chrome/Gold			
<b>WB 007 - CORNER BASKET - LARGE</b>					
	WB 007 C	Chrome			
	WB 007 CG	Chrome/Gold			
<b>WB 008 - CORNER BASKET - MEDIUM</b>					
	WB 008 C	Chrome			
	WB 008 CG	Chrome/Gold			
<b>WB 009 - CORNER BASKET - SMALL</b>					
	WB 009 C	Chrome			
	WB 009 CG	Chrome/Gold			
<b>WB 010 - SEMI-CIRCULAR BASKET - LARGE</b>					
	WB 010 C	Chrome			
	WB 010 CG	Chrome/Gold			

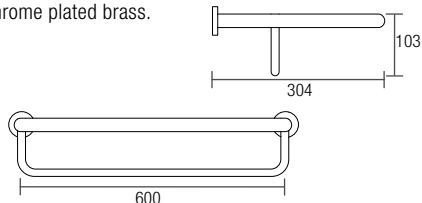
# BATHROOM RAILS - COMFORT COLLECTION



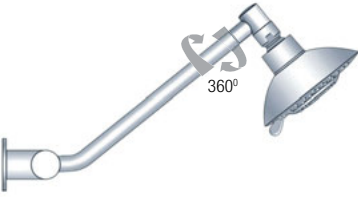

All purpose 25 mm rail for kitchen and bathroom support use. Not specifically designed for people with disabilities. Fabricated from 304 stainless steel with 50 mm triple screw wall mount plates and screw on end caps.

Coloured rails are only made to order and are non-returnable.

	Code	Finish	Without GST	With GST	Features
<b>300 mm - 25 mm COMFORT RAIL</b>					
	CR 300 PS	Polish Supreme™			300 mm Ø to Ø wall fixings. Stainless steel 304. 
	CR 300 FC	Full Colour			
	CR 300 ACG	Colour/Gold			
	CR 300 G	Gold			
<b>450 mm - 25 mm COMFORT RAIL</b>					
	CR 450 PS	Polish Supreme™			450 mm Ø to Ø wall fixings. Stainless steel 304. 
	CR 450 FC	Full Colour			
	CR 450 ACG	Colour/Gold			
	CR 450 G	Gold			
<b>600 mm - 25 mm COMFORT RAIL</b>					
	CR 600 PS	Polish Supreme™			600 mm Ø to Ø wall fixings. Stainless steel 304. 
	CR 600 FC	Full Colour			
	CR 600 ACG	Colour/Gold			
	CR 600 G	Gold			
<b>900 mm - 25 mm COMFORT RAIL</b>					
	CR 900 PS	Polish Supreme™			900 mm Ø to Ø wall fixings. Stainless steel 304. 
	CR 900 FC	Full Colour			
	CR 900 ACG	Colour/Gold			
	CR 900 G	Gold			
<b>1200 mm - 25 mm COMFORT RAIL</b>					
	CR 1200 PS	Polish Supreme™			1200 mm Ø to Ø wall fixings. Stainless steel 304. 
	CR 1200 FC	Full Colour			
	CR 1200 ACG	Colour/Gold			
	CR 1200 G	Gold			
<b>210 mm x 210 mm - 25 mm RAMPED COMFORT RAIL WITH SOAP BASKET</b>					
	CR 036 C	Chrome			385 mm Ø to Ø wall fixings with 133 mm rise. Suitable for either left or right hand installation. Chrome plated brass. 
<b>600 mm - 25 mm BATH TOWEL SHELF</b>					
	CR 022 C	Chrome			600 mm Ø to Ø wall fixings. Chrome plated brass. 



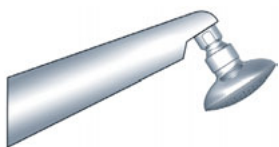

	Code	Finish	Without GST	With GST	Features
<b>OH 001 A - BREEZE PULSATOR ROSE ONLY</b>					
	OH 001 A-C	Chrome			The Breeze spray diffuser is adjustable from firm through soft zones to pulsate-massage. Constructed of ABS with ½" BSP female brass ball joint encased by a nylon ball joint collar for ease of movement and long life. 3 Star - 9 L/min rated as per WELS licence number 0046.
	OH 001 A-WTC	White/Chrome			
	OH 001 A-WTG	White/Gold			
	OH 001 A-CG	Chrome/Gold			
<b>OH 001 B - BREEZE PULSATOR/150 mm UPSWEPT FIXED ARM</b>					
	OH 001 B-C	Chrome			The Breeze pulsator shower rose as described above, is ball joint mounted to a brass 150 mm upswept fixed arm which features a 9 L/min Flow Interchange Spigot. The arm encapsulates the spigot and is fastened by grub screw for final connection. Supplied with 57 mm brass wall flange. 3 Star - 9 L/min rated as per WELS licence number 0046.
	OH 001 B-WTC	White/Chrome			
	OH 001 B-WTG	White/Gold			
	OH 001 B-CG	Chrome/Gold			
<b>OH 001 D - BREEZE PULSATOR/300 mm CLICKLOCK™ ORBITAL/ADJUSTABLE ARM</b>					
	OH 001 D-C	Chrome			The Breeze pulsator shower rose as described above, is ball joint mounted to a brass made 300 mm upswept adjustable arm with anti-droop Clicklock™ elbow mechanism. The arm adjusts vertically and orbits 360° at the shower rose. The arm encapsulates the spigot and is fastened by grub screw for final connection. Supplied with 57 mm brass wall mount flange. 3 Star - 9 L/min, as per WELS licence number 0046.
	OH 001 D-WTC	White/Chrome			
	OH 001 D-WTG	White/Gold			
	OH 001 D-CG	Chrome/Gold			
<b>OH 001 E - BREEZE PULSATOR/290 mm SWAN NECK RISING ARM</b>					
	OH 001 E-C	Chrome			The Breeze pulsator shower rose as described above, is ball joint mounted to a rigid brass 290 mm Swan neck arm which features a 9 L/min Flow Interchange Spigot. The arm encapsulates the spigot and is fastened by grub screw for final connection. Suitable for general applications the swan neck arm projects the shower 200 mm from the wall and increases the height of the shower rose 135 mm above the wall outlet. Supplied with 57 mm brass wall flange. 3 Star - 9 L/min rated as per WELS licence number 0046.
	OH 001 E-WTC	White/Chrome			
	OH 001 E-WTG	White/Gold			
	OH 001 E-CG	Chrome/Gold			
<b>OH 001 F - BREEZE PULSATOR/100 mm FIXED ARM</b>					
	OH 001 F-C	Chrome			The Breeze pulsator shower rose as described above, is ball joint mounted to a brass 100 mm fixed arm which features a 9 L/min Flow Interchange Spigot. Supplied with 57 mm brass wall flange. 3 Star - 9 L/min rated as per WELS licence number 0046.
	OH 001 F-WTC	White/Chrome			
	OH 001 F-WTG	White/Gold			
	OH 001 F-CG	Chrome/Gold			
<b>OH 001 G - BREEZE PULSATOR/165 mm GRAND ARM</b>					
	OH 001 G-C	Chrome			The Breeze pulsator shower rose as described above, is ball joint mounted to a 165 mm cast brass upswept fixed arm with ½" BSP female thread. The arm maintains the height of the shower rose adjacent to the wall outlet without any height loss. Does not require a wall flange. 3 Star - 9 L/min rated as per WELS licence number 0046.
	OH 001 G-WTC	White/Chrome			
	OH 001 G-WTG	White/Gold			
	OH 001 G-CG	Chrome/Gold			







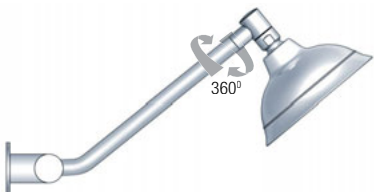

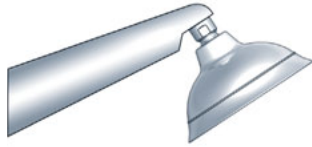
	Code	Finish	Without GST	With GST	Features
<b>OH 003 A - ECLIPSE ROSE ONLY</b>					
	OH 003 A-C	Chrome			Traditional firm full pattern shower with replaceable 80 mm easy clean, corrosion proof and calcium resistant ABS spray diffusor. Dome shower body and heavy ball joint constructed of brass with ½" BSP female connection. 3 Star - 9 L/min rated as per WELS licence number 0046.
	OH 003 A-ACC	Colour/Chrome			
	OH 003 A-ACG	Colour/Gold			
	OH 003 A-SC	Satin Completely			
	OH 003 A-CG	Chrome/Gold			
	OH 003 A-G	Gold			
<b>OH 003 B - ECLIPSE /150 mm UPSWEPT FIXED ARM</b>					
	OH 003 B-C	Chrome			The Eclipse shower rose as described above, is ball joint mounted to a brass 150 mm upswept fixed arm which features a 9 L/min Flow Interchange Spigot. The arm encapsulates the spigot and is fastened by grub screw for final connection. Supplied with 57 mm brass wall flange. 3 Star - 9 L/min rated as per WELS licence number 0046.
	OH 003 B-ACC	Colour/Chrome			
	OH 003 B-ACG	Colour/Gold			
	OH 003 B-SC	Satin Completely			
	OH 003 B-CG	Chrome/Gold			
	OH 003 B-G	Gold			
<b>OH 003 D - ECLIPSE/300 mm CLICKLOCK™ ORBITAL/ADJUSTABLE ARM</b>					
	OH 003 D-C	Chrome			The Eclipse shower rose as described above, is ball joint mounted to a brass made 300 mm upswept adjustable arm with anti-droop Clicklock™ elbow mechanism. The arm adjusts vertically and orbits 360° at the shower rose. The arm encapsulates the spigot and is fastened by grub screw for final connection. Supplied with 57 mm brass wall mount flange. 3 Star - 9 L/min rated as per WELS licence number 0046.
	OH 003 D-ACC	Colour/Chrome			
	OH 003 D-ACG	Colour/Gold			
	OH 003 D-SC	Satin Completely			
	OH 003 D-CG	Chrome/Gold			
	OH 003 D-G	Gold			
<b>OH 003 E - ECLIPSE/290 mm SWAN NECK RISING ARM</b>					
	OH 003 E-C	Chrome			The Eclipse shower rose as described above, is ball joint mounted to a rigid brass 290 mm Swan neck arm which features a 9 L/min Flow Interchange Spigot. The arm encapsulates the spigot and is fastened by grub screw for final connection. Suitable for general applications the swan neck arm projects the shower 200 mm from the wall and increases the height of the shower rose 135 mm above the wall outlet. Supplied with 57 mm brass wall flange. 3 Star - 9 L/min rated as per WELS licence number 0046.
	OH 003 E-ACC	Colour/Chrome			
	OH 003 E-ACG	Colour/Gold			
	OH 003 E-SC	Satin Completely			
	OH 003 E-CG	Chrome/Gold			
	OH 003 E-G	Gold			
<b>OH 003 F - ECLIPSE/100 mm FIXED ARM</b>					
	OH 003 F-C	Chrome			The Eclipse shower rose as described above, is ball joint mounted to a brass 100 mm fixed arm which features a 9 L/min Flow Interchange Spigot. Supplied with 57 mm brass wall flange. 3 Star - 9 L/min rated as per WELS licence number 0046.
	OH 003 F-ACC	Colour/Chrome			
	OH 003 F-ACG	Colour/Gold			
	OH 003 F-SC	Satin Completely			
	OH 003 F-CG	Chrome/Gold			
	OH 003 F-G	Gold			
<b>OH 003 G - ECLIPSE/165 mm GRAND ARM</b>					
	OH 003 G-C	Chrome			The Eclipse shower rose as described above, is ball joint mounted to a 165 mm cast brass upswept fixed arm with ½" BSP female thread. The arm maintains the height of the shower rose adjacent to the wall outlet without any height loss. Does not require a wall flange. 3 Star - 9 L/min rated as per WELS licence number 0046.
	OH 003 G-ACC	Colour/Chrome			
	OH 003 G-ACG	Colour/Gold			
	OH 003 G-SC	Satin Completely			
	OH 003 G-CG	Chrome/Gold			
	OH 003 G-G	Gold			

Domed shower 90 mm rub clean diffuser in traditional single pattern spray. Suited to difficult pressure applications, gravity fed tanks and instantaneous heaters.  
For 15 L/min and 12 L/min, purchase a Flow Interchange Spigot on p. 42.







	Code	Finish	Without GST	With GST	Features
<b>OH 005 A - PADDINGTON ROSE ONLY</b>					
	OH 005 A-C	Chrome			Prestige, modern ABS 90 mm domed shower rose diffuser with firm full pattern rub-clean, corrosion proof spray diffuser. Designed with 1/2" BSP female connection brass ball joint encased by a nylon ball joint collar for ease of movement and long life. 3 Star - 9 L/min rated as per WELS licence number 0046.
	OH 005 A-ACC	Colour/Chrome			
	OH 005 A-ACG	Colour/Gold			
	OH 005 A-SC	Satin Completely			
	OH 005 A-PB	Polished Brass			
	OH 005 A-CG	Chrome/Gold			
	OH 005 A-G	Gold			
<b>OH 005 B - PADDINGTON/150 mm UPSWEPT FIXED ARM</b>					
	OH 005 B-C	Chrome			The Paddington shower rose as described above, is ball joint mounted to a brass 150 mm upswept fixed arm which features a 9 L/min Flow Interchange Spigot. The arm encapsulates the spigot and is fastened by grub screw for final connection. Supplied with 57 mm brass wall flange. 3 Star - 9 L/min rated as per WELS licence number 0046.
	OH 005 B-ACC	Colour/Chrome			
	OH 005 B-ACG	Colour/Gold			
	OH 005 B-SC	Satin Completely			
	OH 005 B-CG	Chrome/Gold			
	OH 005 B-G	Gold			
<b>OH 005 D - PADDINGTON/300 mm CLICKLOCK™ ORBITAL/ADJUSTABLE ARM</b>					
	OH 005 D-C	Chrome			The Paddington shower rose as described above, is ball joint mounted to a brass made 300 mm upswept adjustable arm with anti-droop Clicklock™ elbow which features a 9 L/min Flow Interchange Spigot. The arm adjusts vertically and orbits 360° at the shower rose. The arm encapsulates the spigot and is fastened by grub screw for final connection. Supplied with 57 mm brass wall mount flange. 3 Star - 9 L/min rated as per WELS licence number 0046.
	OH 005 D-ACC	Colour/Chrome			
	OH 005 D-ACG	Colour/Gold			
	OH 005 D-SC	Satin Completely			
	OH 005 D-CG	Chrome/Gold			
	OH 005 D-G	Gold			
<b>OH 005 E - PADDINGTON/290 mm SWAN NECK RISING ARM</b>					
	OH 005 E-C	Chrome			The Paddington shower rose as described above, is ball joint mounted to a rigid brass 290 mm swan neck arm which features a 9 L/min Flow Interchange Spigot. The arm encapsulates the spigot and is fastened by grub screw for final connection. Suitable for general applications the swan neck arm projects the shower 200 mm from the wall and increases the height of the shower rose 145 mm above the wall outlet. Supplied with 57 mm brass wall flange. 3 Star - 9 L/min rated as per WELS licence number 0046.
	OH 005 E-ACC	Colour/Chrome			
	OH 005 E-ACG	Colour/Gold			
	OH 005 E-SC	Satin Completely			
	OH 005 E-PB	Polished Brass			
	OH 005 E-CG	Chrome/Gold			
	OH 005 E-G	Gold			
<b>OH 005 V - PADDINGTON/350 mm VERTICAL ARM</b>					
 450 mm	OH 005 V-C	Chrome			The Paddington shower rose as described above, is ball joint mounted to a brass 350 mm vertical fixed arm which features a 9 L/min Flow Interchange Spigot. The arm encapsulates the spigot and is fastened by grub screw for final connection. Supplied with 57 mm brass wall flange. 3 Star - 9 L/min rated as per WELS licence number 0046.
	OH 005 V-G	Gold			
<b>OH 005 G - PADDINGTON/165 mm GRAND ARM</b>					
	OH 005 G-C	Chrome			The Paddington shower rose as described above, is ball joint mounted to a 165 mm cast brass fixed arm with 1/2" BSP female thread. The arm maintains the height of the shower rose adjacent to the wall outlet without any height loss. Flow regulated to 9 L/min. Does not require a wall flange. 3 Star - 9 L/min rated as per WELS licence number 0046.
	OH 005 G-ACC	Colour/Chrome			
	OH 005 G-ACG	Colour/Gold			
	OH 005 G-SC	Satin Completely			
	OH 005 G-CG	Chrome/Gold			
	OH 005 G-G	Gold			

	Code	Finish	Without GST	With GST	Features
<b>OH 007 A - GRENADA ROSE ONLY</b>					
	OH 007 A-C	Chrome			Traditional firm full pattern shower with 50 mm rub-clean feature. Constructed of ABS with brass ball joint encased by a nylon ball joint collar for ease of movement and long life. Comes with ½" BSP female connection. 3 Star - 7 L/min and 9 L/min rated as per WELS licence number 0046.
	OH 007 A-WTC	White / Chrome			
<b>OH 007 B - GRENADA/150 mm UPSWEPT FIXED ARM</b>					
	OH 007 B-C	Chrome			The Grenada shower rose as described above, is ball joint mounted to a brass 150 mm upswept fixed arm which features a 9 L/min Flow Interchange Spigot. The arm encapsulates the spigot and is fastened by grub screw for final connection. Supplied with 57 mm brass wall flange. 3 Star - 7 L/min and 9 L/min rated as per WELS licence number 0046.
	OH 007 B-WTC	White / Chrome			
<b>OH 007 C - GRENADA/260 mm UPSWEPT ADJUSTABLE ARM</b>					
	OH 007 C-C	Chrome			The Grenada shower rose as described above, is ball joint mounted to a lite-style 260 mm brass constructed adjustable arm for shower support and flow regulation of 9 L/min. The ½" wall mount connection is tensioned with a nylon grip olive seal. Arm supplied with domed flange. 3 Star - 7 L/min and 9 L/min rated as per WELS licence number 0046.
	OH 007 C-WTC	White/Chrome			
	OH 007 C-WTG	White/Gold			
<b>OH 007 F - GRENADA/100 mm FIXED ARM</b>					
	OH 007 F-C	Chrome			The Grenada shower rose is ball joint mounted to a solid brass 100 mm fixed arm which features a 9 L/min Flow Interchange Spigot. The arm encapsulates the spigot and is fastened by grub screw for final connection. Supplied with 57 mm brass wall flange. 3 Star - 7 L/min and 9 L/min rated as per WELS licence number 0046.
	OH 007 F-WTC	White / Chrome			
<b>OH 007 G - GRENADA/165 mm GRAND ARM</b>					
	OH 007 G-C	Chrome			The Grenada shower rose as described above, is ball joint mounted to a 165 mm cast brass fixed arm with ½" BSP female thread. The arm maintains the height of the shower rose adjacent to the wall outlet without any height loss. Does not require a wall flange. 3 Star - 7 L/min and 9 L/min rated as per WELS licence number 0046.
	OH 007 G-WTC	White / Chrome			
<b>OH 007 L - GRENADA/55 mm LIMITED PROJECTION ARM</b>					
	OH 007 L-C	Chrome			The Grenada shower rose is ball joint mounted to a solid brass 55 mm limited projection fixed arm which features a 9 L/min Flow Interchange Spigot. The arm encapsulates the spigot and is fastened by grub screw for final connection. Most suitable for small shower cubicles. Supplied with 57 mm brass wall flange. 3 Star - 7 L/min and 9 L/min rated as per WELS licence number 0046.
	OH 007 L-WTC	White / Chrome			

A premium shower with traditional concentric single pattern jet spray diffusor producing a generous full pattern band of spray circles giving a most pleasant and effective dense shower.  
For 15 L/min and 12 L/min, purchase a Flow Interchange Spigot on p. 42.

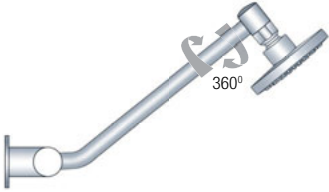
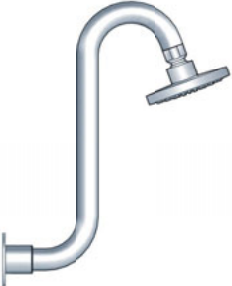

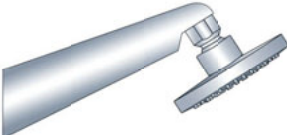





	Code	Finish	Without GST	With GST	Features
<b>OH 006 A - STREAMJET™ ROSE ONLY</b>					
	OH 006 A-C	Chrome			Premium, ABS 100 mm single function shower rose with firm, full pattern, rub-clean, corrosion proof spray diffusor. Designed with ½" BSP female connection brass ball joint, encased by a nylon wear resistant ball joint collar for ease of movement and long life. 3 Star - 9 L/min rated as per WELS licence number 0046.
	OH 006 A-WTC	White/Chrome			
	OH 006 A-WTG	White/Gold			
	OH 006 A-CG	Chrome/Gold			
	OH 006 A-G	Gold			
<b>OH 006 B - STREAMJET™/150 mm UPSWEPT FIXED ARM</b>					
	OH 006 B-C	Chrome			The Streamjet™ shower rose as described above, is ball joint mounted to a brass 150 mm upswept fixed arm which features a 9 L/min Flow Interchange Spigot. The upswept design maintains the height of the shower rose adjacent to the wall outlet without any height loss. The arm encapsulates the spigot and is fastened by grub screw for final connection. Supplied with 57 mm brass wall flange. 3 Star - 9 L/min rated as per WELS licence number 0046.
	OH 006 B-WTC	White/Chrome			
	OH 006 B-WTG	White/Gold			
	OH 006 B-CG	Chrome/Gold			
	OH 006 B-G	Gold			
<b>OH 006 D - STREAMJET™/300 mm CLICKLOCK™/ORBITAL ADJUSTABLE ARM</b>					
	OH 006 D-C	Chrome			The Streamjet™ shower rose as described above, is ball joint mounted to a brass made 300 mm upswept adjustable arm with anti-droop Clicklock™ elbow mechanism. The arm adjusts vertically and orbits 360° at the shower rose. The arm encapsulates the spigot and is fastened by grub screw for final connection. Supplied with 57 mm brass wall mount flange. 3 Star - 9 L/min rated as per WELS licence number 0046.
	OH 006 D-WTC	White/Chrome			
	OH 006 D-WTG	White/Gold			
	OH 006 D-SC	Satin Completely			
	OH 006 D-CG	Chrome/Gold			
	OH 006 D-G	Gold			
<b>OH 006 E - STREAMJET™/290 mm SWAN NECK RISING ARM</b>					
	OH 006 E-C	Chrome			The Streamjet™ shower rose as described above, is ball joint mounted to a rigid brass 290 mm swan neck arm which features a 9 L/min Flow Interchange Spigot. The arm encapsulates the spigot and is fastened by a grub screw for final connection. Suitable for general applications, the swan neck arm projects the shower 200 mm from the wall and increases the height of the shower rose 145 mm above the wall outlet. Supplied with 57 mm brass wall flange. 3 Star - 9 L/min rated as per WELS licence number 0046.
	OH 006 E-WTC	White/Chrome			
	OH 006 E-WTG	White/Gold			
	OH 006 E-CG	Chrome/Gold			
	OH 006 E-G	Gold			
<b>OH 006 F - STREAMJET™/100 mm FIXED ARM</b>					
	OH 006 F-C	Chrome			The Streamjet™ shower rose as described above, is ball joint mounted to a brass 100 mm fixed arm which features a 9 L/min Flow Interchange Spigot. Supplied with 57 mm brass wall flange. 3 Star - 9 L/min rated as per WELS licence number 0046.
	OH 006 F-WTC	White/Chrome			
	OH 006 F-WTG	White/Gold			
	OH 006 F-CG	Chrome/Gold			
	OH 006 F-G	Gold			
<b>OH 006 G - STREAMJET™/165 mm GRAND ARM</b>					
	OH 006 G-C	Chrome			The Streamjet™ shower rose as described above, is ball joint to a 165 mm cast brass upswept fixed arm with ½" BSP female thread. The arm maintains the height of the shower rose adjacent to the wall outlet without any height loss. Does not require a wall flange. 3 Star - 9 L/min rated as per WELS licence number 0046.
	OH 006 G-WTC	White/Chrome			
	OH 006 G-WTG	White/Gold			
	OH 006 G-CG	Chrome/Gold			
	OH 006 G-G	Gold			

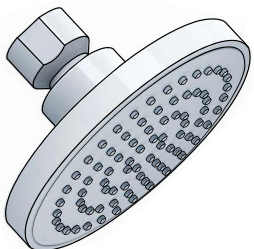
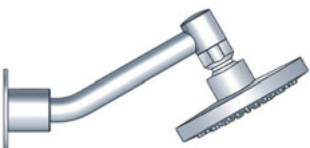
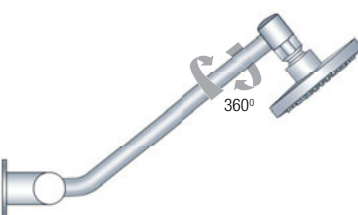

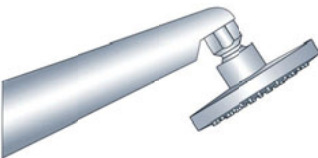

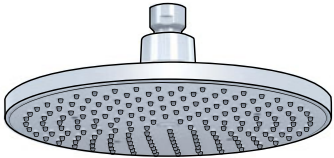
A premium extra large (XL) ABS 130 mm chrome face shower with traditional concentric single pattern jet spray with rub-clean diffusor producing a generous rain-like full pattern spray for a soothing and relaxing shower. For 15 L/min and 12 L/min, purchase a Flow Interchange Spigot on p.42.

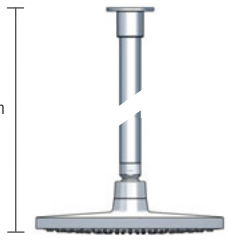

	Code	Finish	Without GST	With GST	Features
<b>OH 008 A - STREAMJET™ -XL ROSE ONLY</b>					
	OH 008 A-C	Chrome			Premium, large 130 mm chrome face single function shower rose with firm, full pattern, rub-clean spray diffusor. Designed with ½" BSP female connection brass ball joint encased by a nylon wear resistant ball joint collar for ease of movement and long life. 3 Star - 9 L/min rated as per WELS licence number 0046.
	OH 008 A-CG	Chrome/Gold			
	OH 008 A-G	Gold			
<b>OH 008 B - STREAMJET™ -XL / 150 mm UPSWEPT FIXED ARM</b>					
	OH 008 B-C	Chrome			The Streamjet™ - XL shower rose as described above, is ball joint mounted to a brass 150 mm upswept fixed arm which features a 9 L/min Flow Interchange Spigot. The upswept design maintains the height of the shower rose adjacent to the wall outlet without any height loss. The arm encapsulates the spigot and is fastened by grub screw for final connection. Supplied with 57 mm brass wall flange. 3 Star - 9 L/min rated as per WELS licence number 0046.
	OH 008 B-CG	Chrome/Gold			
	OH 008 B-G	Gold			
<b>OH 008 D - STREAMJET™ -XL / 300 mm CLICKLOCK™/ORBITAL ADJUSTABLE ARM</b>					
	OH 008 D-C	Chrome			The Streamjet™ - XL shower rose as described above, is ball joint mounted to a brass made 300 mm upswept adjustable arm with anti-droop Clicklock™ elbow mechanism. The arm adjusts vertically and orbits 360° at the shower rose. The arm encapsulates the spigot and is fastened by grub screw for final connection. Supplied with 57 mm brass wall flange. 3 Star - 9 L/min rated as per WELS licence number 0046.
	OH 008 D-SC	Satin Completely			
	OH 008 D-CG	Chrome/Gold			
	OH 008 D-G	Gold			
<b>OH 008 E - STREAMJET™ -XL / 290 mm SWAN NECK RISING ARM</b>					
	OH 008 E-C	Chrome			The Streamjet™ - XL shower rose as described above, is ball joint mounted to a rigid brass 290 mm swan neck arm which features a 9 L/min Flow Interchange Spigot. The arm encapsulates the spigot and is fastened by a grub screw for final connection. Suitable for general applications, the swan neck arm projects the shower 200 mm from the wall and increases the height of the shower rose 145 mm above the wall outlet. Supplied with 57 mm brass wall flange. 3 Star - 9 L/min rated as per WELS licence number 0046.
	OH 008 E-CG	Chrome/Gold			
	OH 008 E-G	Gold			
<b>OH 008 F - STREAMJET™ -XL / 100 mm FIXED ARM</b>					
	OH 008 F-C	Chrome			The Streamjet™ - XL shower rose as described above, is ball joint mounted to a brass 100 mm fixed arm which features a 9 L/min Flow Interchange Spigot. The arm encapsulates the spigot and is fastened by a grub screw for final connection. Supplied with 57 mm brass wall flange. 3 Star - 9 L/min rated as per WELS licence number 0046.
	OH 008 F-CG	Chrome/Gold			
	OH 008 F-G	Gold			
<b>OH 008 G - STREAMJET™ -XL / 165 mm GRAND ARM</b>					
	OH 008 G-C	Chrome			The Streamjet™ - XL shower rose as described above, is ball joint mounted to a 165 mm cast brass upswept fixed arm with ½" BSP female thread. The arm maintains the height of the shower rose adjacent to the wall outlet without any height loss. Does not require a wall flange. 3 Star - 9 L/min rated as per WELS licence number 0046.
	OH 008 G-CG	Chrome/Gold			
	OH 008 G-G	Gold			

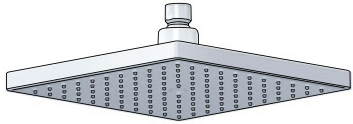

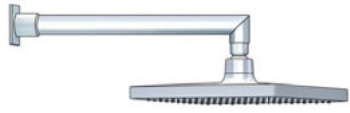
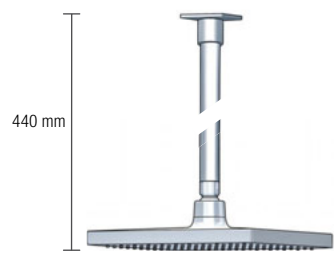
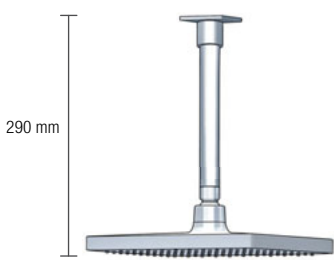

	Code	Finish	Without GST	With GST	Features
<b>OH 028 A - COSMIC ROSE ONLY</b>					
	OH 028 A-C	Chrome			220 mm chrome plated ABS shower rose with full pattern rub-clean, corrosion proof spray diffusor. Designed with 1/2" BSP female connection brass ball joint encased by a nylon ball joint collar for ease of movement and long life. 3 Star - 9 L/min and 2 Star - 12 L/min rated as per WELS licence number 0046.
	OH 028 A-CG	Chrome/Gold			
<b>OH 028 S - COSMIC 345 mm SWIVEL SWAN NECK ARM</b>					
	OH 028 S-C	Chrome			The Cosmic shower rose as described above is ball joint mounted to a brass 345 mm 1/2" M & F swivel Swan Neck Arm. The arm increases the shower rose 250 mm above the wall outlet and projects the shower rose 345 mm from the wall. A 1/2" BSP spigot screws onto the wall outlet. The arm encapsulates the spigot and is fastened by grub screw for final connection. Supplied with 57 mm flat flange. 3 Star - 9 L/min and 2 Star - 12 L/min rated as per WELS licence number 0046.
	OH 028 S-CG	Chrome/Gold			
<b>OH 028 H - COSMIC 310 mm HORIZONTAL ARM</b>					
	OH 028 H-C	Chrome			The Cosmic shower rose as described above is ball joint mounted to a brass 310 mm horizontal style fixed arm. A 1/2" BSP Spigot screws onto the wall outlet. The arm encapsulates the spigot and is fastened by grub screw for final connection. Supplied with 57 mm flat flange. 3 Star - 9 L/min and 2 Star - 12 L/min rated as per WELS licence number 0046.
	OH 028 H-CG	Chrome/Gold			
<b>OH 028 V - COSMIC 350 mm VERTICAL ARM</b>					
 440 mm	OH 028 V-C	Chrome			The Cosmic shower rose as described above is ball joint mounted to a brass 350 mm 1/2" M & F vertical style fixed arm. Designed for ceiling overhead installations. A 1/2" BSP spigot screws onto the ceiling outlet. The arm encapsulates the spigot and is fastened by grub screw for final connection. Supplied with 57 mm flat flange. 3 Star - 9 L/min and 2 Star - 12 L/min rated as per WELS licence number 0046.
	OH 028 V-CG	Chrome/Gold			
<b>OH 028 P - COSMIC 200 mm VERTICAL ARM</b>					
 290 mm	OH 028 P-C	Chrome			The Cosmic shower rose as described above is ball joint mounted to a brass 200 mm 1/2" M & F vertical style fixed arm. Designed for ceiling overhead installations. A 1/2" BSP spigot screws onto the ceiling outlet. The arm encapsulates the spigot and is fastened by grub screw for final connection. Supplied with 57 mm flat flange. 3 Star - 9 L/min and 2 Star - 12 L/min rated as per WELS licence number 0046.
	OH 028 P-CG	Chrome/Gold			

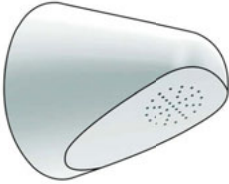
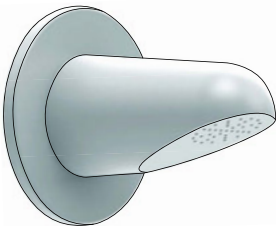
	Code	Finish	Without GST	With GST	Features
<b>OH 030 A - QUEWB ROSE ONLY</b>					
	OH 030 A-C	Chrome			220 mm x 220 mm square chrome plated ABS shower rose with full pattern rub-clean, corrosion proof spray diffuser. Designed with 1/2" BSP female connection brass ball joint, encased by a nylon ball joint collar for ease of movement and long life. 3 Star - 9 L/min and 2 Star - 12 L/min rated as per WELS licence number 0046.
	OH 030 A-CG	Chrome/Gold			
<b>OH 030 Q - QUEWB 380 mm SWIVEL CRANE NECK ARM</b>					
	OH 030 Q-C	Chrome			The Quewb shower rose as described above is ball joint mounted to a brass 380 mm 1/2" M & F swivel Crane Neck arm. The arm increases the shower rose 250 mm above the wall outlet and projects the shower rose 380 mm from the wall. A 1/2" BSP spigot screws onto the wall outlet. The arm encapsulates the spigot and is fastened by grub screw for final connection. Supplied with 57 mm square flat flange. 3 Star - 9 L/min and 2 Star - 12 L/min rated as per WELS licence number 0046.
	OH 030 Q-CG	Chrome/Gold			
<b>OH 030 H - QUEWB 310 mm HORIZONTAL ARM</b>					
	OH 030 H-C	Chrome			The Quewb shower rose as described above is ball joint mounted to a brass 310 mm horizontal style fixed arm. A 1/2" BSP spigot screws onto the wall outlet. The arm encapsulates the spigot and is fastened by grub screw for final connection. Supplied with 57 mm square flat flange. 3 Star - 9 L/min and 2 Star - 12 L/min rated as per WELS licence number 0046.
	OH 030 H-CG	Chrome/Gold			
<b>OH 030 V - QUEWB 350 mm VERTICAL ARM</b>					
	OH 030 V-C	Chrome			The Quewb shower rose as described above is ball joint mounted to a brass 350 mm 1/2" M & F vertical style fixed arm. Designed for ceiling overhead installations. A 1/2" BSP spigot screws onto the ceiling outlet. The arm encapsulates the spigot and is fastened by grub screw for final connection. Supplied with 57 mm square flat flange. 3 Star - 9 L/min and 2 Star - 12 L/min rated as per WELS licence number 0046.
	OH 030 V-CG	Chrome/Gold			
<b>OH 030 P - QUEWB 200 mm VERTICAL ARM</b>					
	OH 030 P-C	Chrome			The Quewb shower rose as described above is ball joint mounted to a brass 200 mm 1/2" M & F perpendicular style fixed arm. Designed for ceiling overhead installations. A 1/2" BSP spigot screws onto the ceiling outlet. The arm encapsulates the spigot and is fastened by grub screw for final connection. Supplied with 57 mm square flat flange. 3 Star - 9 L/min and 2 Star - 12 L/min rated as per WELS licence number 0046.
	OH 030 P-CG	Chrome/Gold			

## HEAVY DUTY SHOWER

	Code	Finish	Without GST	With GST	Features
<b>CS 007 C - COBRA</b>					
	CS 007 C	Chrome			Heavy duty, brass construction, 55 mm projection detention shower with 17 degree slope and 25 mm fixed angle concentric jet spray diffuser. A ½" BSP Flow Interchange Spigot which features 9 L/min flow regulation is mounted flush to the wall outlet. The shower body encapsulates the spigot and is fastened by grub screw for final connection. 3 Star - 9 L/min rated as per WELS licence number 0046.  Maximum spray projection 900 mm.
<b>CS 009 C - VANGUARD</b>					
	CS 009 C	Chrome			Heavy duty, brass construction, 65 mm projection with 20 mm fused, brass made, concentric jet spray diffuser. A ½" BSP Flow Interchange Spigot which features 9 L/min flow regulation is mounted flush to the wall outlet. The shower body encapsulates the spigot and is fastened by grub screw for final connection. 3 Star - 9 L/min rated as per WELS licence number 0046.  Maximum spray projection 930 mm.
	CS 009 SC	Satin Completely			

## TAMPER PROOF SHOWERS

<b>CS 008 C - PIONEER</b>					
	CS 008 C	Chrome			Prestige brass, heavy duty 125 mm long waisted shower combining unique anti-droop spring tensioned ball joint and 20 mm ABS spray diffuser which features a 9 L/min Flow Interchange Spigot. The shower encapsulates the spigot and is fastened by grub screw for final connection. Supplied with 57 mm wall flange. 3 Star - 6 L/min and 9 L/min rated as per WELS licence number 0046.
	CS 008 ACC	Colour/Chrome			
	CS 008 ACG	Colour/Gold			
	CS 008 SC	Satin Completely			
	CS 008 CG	Chrome/Gold			
	CS 008 G	Gold			
<b>CS 051 C - ECLIPSE/55 mm FIXED ARM</b>					
	CS 051 C	Chrome			The Eclipse is ball joint mounted to a brass 55 mm limited projection fixed arm with grub screw locking system. A ½" BSP 9 L/min Flow Interchange Spigot. The shower arm encapsulates the spigot and is fastened by grub screw for final connection. Supplied with 57 mm wall flange. 3 Star - 9 L/min rated as per WELS licence number 0046.
	CS 051 SC	Satin Completely			
<b>CS 061 C - ZODIAC/55 mm FIXED ARM</b>					
	CS 061 C	Chrome			The Zodiac is ball joint mounted to a brass 55 mm limited projection fixed arm with grub screw locking system. A ½" BSP 9 L/min Flow Interchange Spigot screws onto the wall outlet. The shower arm encapsulates the spigot and is fastened by grub screw for final connection. Supplied with 57 mm wall flange. 3 Star - 9 L/min rated as per WELS licence number 0046.
	CS 061 SC	Satin Completely			
<b>CS 071 C - ZODIAC/100 mm FIXED ARM</b>					
	CS 071 C	Chrome			The Zodiac is ball joint mounted to a brass 100 mm fixed arm with grub screw locking system. A ½" BSP 9 L/min Flow Interchange Spigot screws onto the wall outlet. The shower arm encapsulates the spigot and is fastened by grub screw for final connection. Supplies with 57 mm wall flange. 3 Star - 9 L/min rated as per WELS licence number 0046.
	CS 071 SC	Satin Completely			



# STREAMJET™ Mix and Match Handpiece Options

Introducing Con-Serv's exclusive STREAMJET™ collection of Italian designed handshowers, where minimalist beauty and high performance come together to create a variety of contemporary showers offering total rejuvenation while utilising the best in water conservation technology. Simply select the handpiece with the spray option and match it with the handheld shower combination which best suit customer requirements to create a personalised showering environment.

Refer to handheld shower pages 20 -31 for full kit model numbers and pricing.



## Streamjet™ - Traditional

ABS 100 mm handpiece featuring traditional concentric single pattern jet spray with rub-clean diffuser, producing a generous full pattern band of spray circles giving the most pleasant and effective dense shower.

Handpiece Model Number	Without GST	With GST
HP 038 C		
HP 038 WT		



## Streamjet™ - Turbo Pulsator

ABS 100 mm handpiece with multiple functions featuring firm concentric jet spray with rub-clean diffuser, adjustment through soft zones graduating to turbo pulsating action providing aqua-massage hydrotherapy treatment for health and well being.

Handpiece Model Number	Without GST	With GST
HP 042 C		



## Streamjet™ - XL

Extra Large (XL) ABS 130 mm chrome face handpiece with traditional concentric single pattern jet spray with rub-clean diffuser producing a generous rain-like full pattern spray for a soothing and relaxing shower.







Handpiece Model Number	Without GST	With GST
HP 130 C		

Matching overhead showers on page 14-15

# HANDHELD SHOWERS - CRYSTAL RAIL OPTIONS

Premium Slide Track with Friction Slide Cradle for handset support. Most suitable for persons with weakened wrists, arthritic and grip problems.  
For 15 L/min and 12 L/min, purchase a Flow Interchange Spigot on p. 42.









	Code	Finish	Without GST	With GST	Features
<b>HS 010 C - CHAMPAGNE PULSATOR</b>					
	HS 010 C-C	Chrome			Stylish arched shape ABS handpiece, adjustable from firm spray through soft zones to pulsate-massage and soothing relaxing bubble spray. The Champagne is supplied with appropriate coloured PVC 1.5 m hose and 585 mm Friction Slide Track Cradle for handset support and movement with 55 mm DR brass wall outlet elbow which features 9 L/min Flow Interchange Spigot and separate licenced dual check/non-return valve to prevent back siphonage. Supplied with 57 mm solid brass flat flange. 3 Star - 9 L/min, 2 Star -12 L/min rated as per WELS licence number 0046.
	HS 010 C-WTC	White/Chrome			
	HS 010 C-WTG	White/Gold			
	HS 010 C-SC	Satin Completely			
	HS 010 C-CG	Chrome/Gold			
	HS 010 C-G	Gold			
<b>HS 010 Z - BREEZE PULSATOR</b>					
	HS 010 Z-C	Chrome			Stylish arched shape ABS handpiece, adjustable from firm spray through soft zones to pulsate-massage. The Breeze is supplied with appropriate coloured PVC 1.5 m hose and 585 mm Friction Slide Track Cradle for handset support and movement with 55 mm DR brass wall outlet elbow which features 9 L/min Flow Interchange Spigot and separate licenced dual check/non-return valve to prevent back siphonage. Supplied with 57 mm solid brass flat flange. 3 Star - 9 L/min rated as per WELS licence number 0046.
	HS 010 Z-WTC	White/Chrome			
	HS 010 Z-WTG	White/Gold			
	HS 010 Z-CG	Chrome/Gold			
<b>HS 010 P - PRINCESS</b>					
	HS 010 P-C	Chrome			Arched shape performance proven ABS handpiece with single pattern low impact spray with rub-clean corrosion proof diffuser. The Princess is supplied with appropriate coloured PVC 1.5 m hose and 585 mm Friction Slide Track Cradle for handset support and movement with 55 mm DR brass wall outlet elbow which features 9 L/min Flow Interchange Spigot and separate licenced dual check/non-return valve to prevent back siphonage. Supplied with 57 mm solid brass flat flange. 3 Star - 9 L/min rated as per WELS licence number 0046.
	HS 010 P-ACC	Colour/Chrome			
	HS 010 P-ACG	Colour/Gold			
	HS 010 P-SC	Satin Completely			
	HS 010 P-CG	Chrome/Gold			
	HS 010 P-G	Gold			
<b>HS 010 J - STREAMJET™ - TRADITIONAL</b>					
	HS 010 J-C	Chrome			Premium 100 mm ABS handpiece with Traditional concentric single pattern jet spray diffusor, giving the most pleasant dense shower.
	HS 010 J-WTC	White/Chrome			
	HS 010 J-WTG	White/Gold			
	HS 010 J-CG	Chrome/Gold			
<b>HS 010 T - STREAMJET™ - TURBO PULSATOR</b>					
	HS 010 T-C	Chrome			Premium 100 mm ABS handpiece, with multiple functions featuring firm concentric jet spray, adjustable through soft zones to Turbo Pulsating action, providing aqua-massage hydrotherapy treatment.
<b>HS 010 X - STREAMJET™ - XL (EXTRA LARGE)</b>					
	HS 010 X-C	Chrome			Premium 130 mm ABS extra large handpiece with Traditional concentric single jet spray diffusor giving a rain-like full pattern spray.
All Streamjet® models are supplied with appropriate coloured PVC 1.5 m hose and 585 mm Friction Slide Track with cradle for handset support and movement, a DR brass wall outlet elbow which features 9 L/min Flow Interchange Spigot and separate licenced dual check valve to prevent back siphonage. 3 Star - 9 L/min rated as per WELS licence number 0046.					

For handheld or hands free operation, these showers are supported by a wall outlet security bracket and need no fixing screws.

For 15 L/min and 12 L/min, purchase a Flow Interchange Spigot on p. 42.









	Code	Finish	Without GST	With GST	Features
<b>HS 011 C - CHAMPAGNE PULSATOR</b>					
	HS 011 C-C	Chrome			Stylish arched shape ABS handpiece, adjustable from firm spray through soft zones to pulsate-massage and soothing relaxing bubble spray. The Champagne is supplied with appropriate coloured PVC 1.5 m hose and wall outlet elbow bracket which features 9 L/min Flow Intechange Spigot and separate licenced dual check/non-return valve to prevent back siphonage. Supplied with 57 mm solid brass flat flange. 3 Star - 9 L/min, 2 Star - 12 L/min rated as per WELS licence number 0046.
	HS 011 C-WTC	White/Chrome			
	HS 011 C-WTG	White/Gold			
	HS 011 C-SC	Satin Completely			
	HS 011 C-CG	Chrome/Gold			
	HS 011 C-G	Gold			
<b>HS 011 Z - BREEZE PULSATOR</b>					
	HS 011 Z-C	Chrome			Stylish arched shape ABS handpiece, adjustable from firm spray through soft zones to pulsate-massage. The Breeze is supplied with appropriate coloured PVC 1.5 m hose and wall outlet elbow bracket which features 9 L/min Flow Intechange Spigot and separate licenced dual check/non-return valve to prevent back siphonage. Supplied with 57 mm solid brass flat flange. 3 Star - 9 L/min rated as per WELS licence number 0046.
	HS 011 Z-WTC	White/Chrome			
	HS 011 Z-WTG	White/Gold			
	HS 011 Z-CG	Chrome/Gold			
<b>HS 011 P - PRINCESS</b>					
	HS 011 P-C	Chrome			Arched shape performance proven ABS handpiece with single pattern low impact spray with rub-clean corrosion proof diffuser. The Princess is supplied with appropriate coloured PVC 1.5 m hose and wall outlet elbow bracket which features 9 L/min Flow Intechange Spigot and separate licenced dual check/non-return valve to prevent back siphonage. Supplied with 57 mm solid brass flat flange. 3 Star - 9 L/min rated as per WELS licence number 0046.
	HS 011 P-ACC	Colour/Chrome			
	HS 011 P-ACG	Colour/Gold			
	HS 011 P-SC	Satin Completely			
	HS 011 P-CG	Chrome/Gold			
	HS 011 P-G	Gold			
<b>HS 011 J - STREAMJET™ TRADITIONAL</b>					
	HS 011 J-C	Chrome			Premium 100 mm ABS handpiece with Traditional concentric single pattern jet spray diffusor, giving the most pleasant dense shower.
	HS 011 J-WTC	White/Chrome			
	HS 011 J-WTG	White/Gold			
	HS 011 J-CG	Chrome/Gold			
<b>HS 011 T - STREAMJET™ - TURBO PULSATOR</b>					
	HS 011 T-C	Chrome			Premium 100 mm ABS handpiece, with multiple functions featuring firm concentric jet spray, adjustable through soft zones to Turbo Pulsating action, providing aqua-massage hydrotherapy treatment.
<b>HS 011 X - STREAMJET™ - XL (EXTRA LARGE)</b>					
	HS 011 X-C	Chrome			Premium 130 mm ABS extra large handpiece with Traditional concentric single jet spray diffusor giving a rain-like full pattern spray.
					All Streamjet® models are supplied with appropriate coloured PVC 1.5 m hose and wall outlet elbow bracket which features 9 L/min Flow Interchange Spigot and separate licenced dual check/non return valve to prevent back siphonage. 3 Star - 9 L/min rated as per WELS licence number 0046.

# HANDHELD SHOWERS - FOR LOW WATER OUTLETS

These handheld shower sets are **ONLY** for water outlets lower than 1800 mm, for mounting over spa baths or to mount on a wall or separate from the wall outlet. For 15 L/min and 12 L/min, purchase a Flow Interchange Spigot on p. 42.



	Code	Finish	Without GST	With GST	Features
<b>HS 013 C - CHAMPAGNE PULSATOR</b>					
	HS 013 C-C	Chrome			Stylish arched shape ABS handpiece, adjustable from firm spray through soft zones to pulsate-massage and soothing relaxing bubble spray. The Champagne is supplied with appropriate coloured PVC 1.5 m hose and includes a brass spigot wall elbow which features 9 L/min Flow Interchange Spigot and separate licenced dual check/non-return valve to prevent back siphonage and dual screw wall mount bracket. Supplied with 57 mm solid brass flat flange. 3 Star - 9 L/min, 2 Star -12 L/min rated as per WELS licence number 0046.  <b>Handheld shower for water outlets lower than 1800 mm</b>
	HS 013 C-WTC	White/Chrome			
	HS 013 C-WTG	White/Gold			
	HS 013 C-SC	Satin Completely			
	HS 013 C-CG	Chrome/Gold			
	HS 013 C-G	Gold			
<b>HS 013 Z - BREEZE PULSATOR</b>					
	HS 013 Z-C	Chrome			Stylish arched shape ABS handpiece, adjustable from firm spray through soft zones to pulsate-massage. The Breeze is supplied with appropriate coloured PVC 1.5 m hose and includes a brass spigot wall elbow which features 9 L/min Flow Interchange Spigot and separate licenced dual check/non-return valve to prevent back siphonage and dual screw wall mount bracket. Supplied with 57 mm solid brass flat flange. 3 Star - 9 L/min rated as per WELS licence number 0046.  <b>Handheld shower for water outlets lower than 1800 mm</b>
	HS 013 Z-WTC	White/Chrome			
	HS 013 Z-WTG	White/Gold			
	HS 013 Z-CG	Chrome/Gold			
<b>HS 013 P - PRINCESS</b>					
	HS 013 P-C	Chrome			Arched shape performance proven ABS handpiece with single pattern low impact spray with rub-clean corrosion proof diffuser. The Princess is supplied with appropriate coloured PVC 1.5 m hose and includes a brass spigot wall elbow which features 9 L/min Flow Interchange Spigot and separate licenced dual check/non-return valve to prevent back siphonage and dual screw wall mount bracket. Supplied with 57 mm solid brass flat flange. 3 Star - 9 L/min rated as per WELS licence number 0046.  <b>Handheld shower for water outlets lower than 1800 mm</b>
	HS 013 P-ACC	Colour/Chrome			
	HS 013 P-ACG	Colour/Gold			
	HS 013 P-SC	Satin Completely			
	HS 013 P-CG	Chrome/Gold			
	HS 013 P-G	Gold			
<b>HS 013 J - STREAMJET™ - TRADITIONAL</b>					
	HS 013 J-C	Chrome			Premium 100 mm ABS handpiece with Traditional concentric single pattern jet spray diffuser, giving the most pleasant dense shower.
	HS 013 J-WTC	White/Chrome			
	HS 013 J-WTG	White/Gold			
	HS 013 J-CG	Chrome/Gold			
<b>HS 013 T - STREAMJET™ - TURBO PULSATOR</b>					
	HS 013 T-C	Chrome			Premium 100 mm ABS handpiece, with multiple functions featuring firm concentric jet spray, adjustable through soft zones to Turbo Pulsating action, providing aqua-massage hydrotherapy treatment.
<b>HS 013 X - STREAMJET™ - XL (EXTRA LARGE)</b>					
	HS 013 X-C	Chrome			Premium 130 mm ABS extra large handpiece with Traditional concentric single jet spray diffuser giving a rain-like full pattern spray.  All Streamjet® models are supplied with appropriate coloured PVC 1.5 m hose and includes a brass spigot wall elbow which features 9 L/min Flow Interchange Spigot and separate licenced dual check/non-return valve to prevent back siphonage and dual screw wall mount bracket. 3 Star - 9 L/min rated as per WELS licence number 0046.  <b>Handheld shower for water outlets lower than 1800 mm</b>

600 mm x 25 mm Ø to Ø heavy duty brass rail with handset slide cradle and 50 mm screw on concealed end flange covers.  
For 15 L/min and 12 L/min, purchase a Flow Interchange Spigot on p. 42.



	Code	Finish	Without GST	With GST	Features
<b>HS 014 C - CHAMPAGNE PULSATOR</b>					
	HS 014 C-C	Chrome			Stylish arched shape ABS handpiece, adjustable from firm spray through soft zones to pulsate-massage and soothing relaxing bubble spray. The Champagne is supplied with appropriate coloured PVC 1.5 m hose and 600 mm by 25 mm round brass rail. Assembled with 55 mm DR brass wall outlet elbow which features 9 L/min Flow Interchange Spigot and separate licenced dual check/non-return valve to prevent back siphonage. Supplied with 57 mm solid brass flat flange. 3 Star - 9 L/m, 2 Star - 12 L/m rated as per WELS licence number 0046.
	HS 014 C-WTC	White/Chrome			
	HS 014 C-WTG	White/Gold			
	HS 014 C-CG	Chrome/Gold			
<b>HS 014 Z - BREEZE PULSATOR</b>					
	HS 014 Z-C	Chrome			Stylish arched shape ABS handpiece, adjustable from firm spray through soft zones to pulsate-massage. The Breeze is supplied with appropriate coloured PVC 1.5 m hose and 600 mm by 25 mm round brass rail. Assembled with 55 mm DR brass wall outlet elbow which features 9 L/min Flow Interchange Spigot and separate licenced dual check/non-return valve to prevent back siphonage. Supplied with 57 mm solid brass flat flange. 3 Star - 9 L/m rated as per WELS licence number 0046.
	HS 014 Z-WTC	White/Chrome			
	HS 014 Z-WTG	White/Gold			
	HS 014 Z-CG	Chrome/Gold			
<b>HS 014 P - PRINCESS</b>					
	HS 014 P-C	Chrome			Arched shape performance proven ABS handpiece with single pattern low impact spray with rub-clean corrosion proof diffuser. The Princess is supplied with appropriate coloured PVC 1.5 m hose and 600 mm by 25 mm round brass rail. Assembled with 55 mm DR brass wall outlet elbow which features 9 L/min Flow Interchange Spigot and separate licenced dual check/non-return valve to prevent back siphonage. Supplied with 57 mm solid brass flat flange. 3 Star - 9 L/m rated as per WELS licence number 0046.
	HS 014 P-WTC	White/Chrome			
	HS 014 P-WTG	White/Gold			
	HS 014 P-IVC	Ivory/Chrome			
	HS 014 P-IVG	Ivory/Gold			
	HS 014 P-CG	Chrome/Gold			
<b>HS 014 F - HOSFAB</b>					
	HS 014 F-C	Chrome			Arched shape performance proven ABS handpiece with single pattern low impact spray with rub-clean corrosion proof diffuser. The Hosfab is supplied with appropriate coloured PVC 1.5 m hose and 600 mm x 25 mm round brass rail. Assembled with 55 mm DR brass wall outlet elbow which features 9 L/min Flow Interchange Spigot and separate licenced dual check/non-return valve to prevent back siphonage. Supplied with 57 mm solid brass flat flange. 3 Star - 9 L/m rated as per WELS licence number 0046.
	HS 014 F-WTC	White/Chrome			
	HS 014 F-WTG	White/Gold			
	HS 014 F-CG	Chrome/Gold			







# HANDHELD SHOWER KITS - FOR RAILS ONLY

These handheld shower kits are only suitable to mount with existing slide rails.  
**HANDPIECE SUPPORT NOT INCLUDED.**

For 15 L/min and 12 L/min, purchase a Flow Interchange Spigot on p. 42.



	Code	Finish	Without GST	With GST	Features
<b>HS 017 C - CHAMPAGNE PULSATOR</b>					
	HS 017 C-C	Chrome			Stylish arched shape ABS handpiece, adjustable from firm spray through soft zones to pulsate-massage and soothing relaxing bubble spray. The Champagne is supplied with appropriate coloured PVC 1.5 m hose. Assembled with 55 mm DR brass wall outlet elbow which features 9 L/min Flow Interchange Spigot and separate licenced dual check/non-return valve to prevent back siphonage. Supplied with 57 mm solid brass flat flange. 3 Star - 9 L/m, 2 Star - 12 L/m rated as per WELS licence number 0046.
	HS 017 C-WTC	White/Chrome			
	HS 017 C-WTG	White/Gold			
	HS 017 C-SC	Satin Completely			
	HS 017 C-CG	Chrome/Gold			
	HS 017 C-G	Gold			
<b>HS 017 Z - BREEZE PULSATOR</b>					
	HS 017 Z-C	Chrome			Stylish arched shape ABS handpiece, adjustable from firm spray through soft zones to pulsate-massage. The Breeze is supplied with appropriate coloured PVC 1.5 m hose. Assembled with 55 mm DR brass wall outlet elbow which features 9 L/min Flow Interchange Spigot and separate licenced dual check/non-return valve to prevent back siphonage. Supplied with 57 mm solid brass flat flange. 3 Star - 9 L/m rated as per WELS licence number 0046.
	HS 017 Z-WTC	White/Chrome			
	HS 017 Z-WTG	White/Gold			
	HS 017 Z-CG	Chrome/Gold			
<b>HS 017 P - PRINCESS</b>					
	HS 017 P-C	Chrome			Arched shape performance proven ABS handpiece with single pattern low impact spray with rub-clean corrosion proof diffuser. The Princess is supplied with appropriate coloured PVC 1.5 m hose. Assembled with 55 mm DR brass wall outlet elbow which features 9 L/min Flow Interchange Spigot and separate licenced dual check/non-return valve to prevent back siphonage. Supplied with 57 mm solid brass flat flange. 3 Star - 9 L/m rated as per WELS licence number 0046.
	HS 017 P-ACC	Colour/Chrome			
	HS 017 P-ACG	Colour/Gold			
	HS 017 P-SC	Satin Completely			
	HS 017 P-CG	Chrome/Gold			
	HS 017 P-G	Gold			
<b>HS 017 J - STREAMJET™ - TRADITIONAL</b>					
	HS 017 J-C	Chrome			Premium 100 mm ABS handpiece with Traditional concentric single pattern jet spray diffuser, giving the most pleasant dense shower.
	HS 017 J-WTC	White/Chrome			
	HS 017 J-WTG	White/Gold			
	HS 017 J-CG	Chrome/Gold			
<b>HS 017 T - STREAMJET™ - TURBO PULSATOR</b>					
	HS 017 T-C	Chrome			Premium 100 mm ABS handpiece, with multiple functions featuring firm concentric jet spray, adjustable through soft zones to Turbo Pulsating action, providing aqua-massage hydrotherapy treatment.
<b>HS 017 X - STREAMJET™ - XL (EXTRA LARGE)</b>					
	HS 017 X-C	Chrome			Premium 130 mm ABS extra large handpiece with Traditional concentric single jet spray diffuser giving a rain-like full pattern spray.
All Streamjet® models are supplied with appropriate coloured PVC 1.5 m hose and includes a 55 mm DR brass wall outlet elbow which features 9 L/min Flow Interchange Spigot and separate licenced dual check/non-return valve to prevent back siphonage. 3 Star - 9 L/min rated as per WELS licence number 0046.					
<b>IMPORTANT: FOR USE WITH EXISTING SLIDE RAIL ONLY.</b>					

# HANDHELD SHOWERS - WALL MOUNT - DIVERTER

For bath combinations requiring a wall mount shower, install diverter in place of bath outlet and wall mount at desired height.

For 15 L/min and 12 L/min, purchase a Flow Interchange Spigot on p. 42.







	Code	Finish	Without GST	With GST	Features
<b>HS 019 C - CHAMPAGNE PULSATOR</b>					
	HS 019 C-C	Chrome			Stylish arched shape ABS handpiece, adjustable from firm spray through soft zones to pulsate-massage and soothing relaxing bubble spray. The Champagne is supplied with appropriate coloured PVC 1.5 m hose and brass dual screw wall mount bracket for handset support. A brass 150 mm diverter spout is included. 3 Star - 9 L/min rated as per WELS licence number 0046.
	HS 019 C-WTC	White/Chrome			
	HS 019 C-WTG	White/Gold			
	HS 019 C-SC	Satin Completely			
	HS 019 C-CG	Chrome/Gold			
	HS 019 C-G	Gold			
<b>HS 019 Z - BREEZE PULSATOR</b>					
	HS 019 Z-C	Chrome			Stylish arched shape ABS handpiece, adjustable from firm spray through soft zones to pulsate-massage. The Breeze is supplied with appropriate coloured PVC 1.5 m hose and brass dual screw wall mount bracket for handset support. A brass 150 mm diverter spout is included. 3 Star - 9 L/min rated as per WELS licence number 0046.
	HS 019 Z-WTC	White/Chrome			
	HS 019 Z-WTG	White/Gold			
	HS 019 Z-CG	Chrome/Gold			
<b>HS 019 P - PRINCESS</b>					
	HS 019 P-C	Chrome			Arched shape performance proven ABS handpiece with single pattern low impact spray with rub-clean corrosion proof diffuser. The Princess is supplied with appropriate coloured PVC 1.5 m hose and brass dual screw wall mount bracket for handset support. A brass 150 mm diverter spout is included. 3 Star - 9 L/min rated as per WELS licence number 0046.
	HS 019 P-ACC	Colour/Chrome			
	HS 019 P-ACG	Colour/Gold			
	HS 019 P-SC	Satin Completely			
	HS 019 P-CG	Chrome/Gold			
	HS 019 P-G	Gold			
<b>HS 019 J - STREAMJET™ TRADITIONAL</b>					
	HS 019 J-C	Chrome			Premium 100 mm ABS handpiece with Traditional concentric single pattern jet spray diffuser, giving the most pleasant dense shower.
	HS 019 J-WTC	White/Chrome			
	HS 019 J-WTG	White/Gold			
	HS 019 J-CG	Chrome/Gold			
	<b>HS 019 T - STREAMJET™ - TURBO PULSATOR</b>				
	HS 019 T-C	Chrome			Premium 100 mm ABS handpiece, with multiple functions featuring firm concentric jet spray, adjustable through soft zones to Turbo Pulsating action, providing aqua-massage hydrotherapy treatment.
	<b>HS 019 X - STREAMJET™ - XL (EXTRA LARGE)</b>				
	HS 019 X-C	Chrome			Premium 130 mm ABS extra large handpiece with Traditional concentric single jet spray diffuser giving a rain-like full pattern spray.
	All Streamjet® models are supplied with appropriate coloured PVC 1.5 m hose and brass dual screw wall mount bracket for handset support. A brass 150 mm diverter spout is included. 3 Star - 9 L/min rated as per WELS licence number 0046.				

# HANDHELD SHOWERS - POLAR RAIL OPTIONS

700 mm x 25 mm Ø to Ø brass tube rail with strengthened solid brass end mounts and friction slider for handset support.



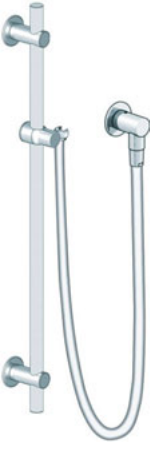

For 15 L/min and 12 L/min, purchase a Flow Interchange Spigot on p. 42.

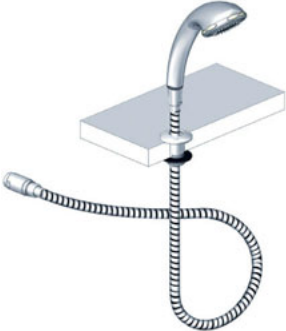

	Code	Finish	Without GST	With GST	Features
<b>HS 020 C - CHAMPAGNE PULSATOR</b>					
	HS 020 C-C	Chrome			<p>Stylish arched shape ABS handpiece, adjustable from firm spray through soft zones to pulsate-massage and soothing relaxing bubble spray. The Champagne is supplied with appropriate coloured PVC 1.5 m hose and 700 mm brass tube rail with floating mount brackets. Assembled with 55 mm DR brass wall outlet elbow which features 9 L/min Flow Interchange Spigot and separate licenced dual check/non-return valve to prevent back siphonage. Supplied with 57 mm solid brass flat flange. 3 Star - 9 L/min, 2 Star - 12 L/min rated as per WELS licence number 0046.</p> <ul style="list-style-type: none"> <li>Oval star pattern</li> <li>Size - 115 mm x 175 mm</li> <li>Clear acrylic for 25 mm rail on p. 45</li> </ul>
	HS 020 C-WTC	White/Chrome			
	HS 020 C-WTG	White/Gold			
	HS 020 C-CG	Chrome/Gold			
		Soap Dish			
	SD 025 CL	Clear			
<b>HS 020 Z - BREEZE PULSATOR</b>					
	HS 020 Z-C	Chrome			<p>Stylish arched shape ABS handpiece, adjustable from firm spray through soft zones to pulsate-massage. The Breeze is supplied with appropriate coloured PVC 1.5 m hose and 700 mm brass tube rail with floating mount brackets. Assembled with 55 mm DR brass wall outlet elbow which features 9 L/min Flow Interchange Spigot and separate licenced dual check/non-return valve to prevent back siphonage. Supplied with 57 mm solid brass flat flange. 3 Star - 9 L/min rated as per WELS licence number 0046.</p> <ul style="list-style-type: none"> <li>Oval star pattern</li> <li>Size - 115 mm x 175 mm</li> <li>Clear acrylic for 25 mm rail on p. 45</li> </ul>
	HS 020 Z-WTC	White/Chrome			
	HS 020 Z-WTG	White/Gold			
	HS 020 Z-CG	Chrome/Gold			
		Soap Dish			
	SD 025 CL	Clear			
<b>HS 020 P - PRINCESS</b>					
	HS 020 P-C	Chrome			<p>Arched shape performance proven ABS handpiece with single pattern low impact spray with rub-clean corrosion proof diffuser. The Princess is supplied with appropriate coloured PVC 1.5 m hose and 700 mm brass tube rail with floating mount brackets. Assembled with 55 mm DR brass wall outlet elbow which features 9 L/min Flow Interchange Spigot and separate licenced dual check/non-return valve to prevent back siphonage. Supplied with 57 mm solid brass flat flange. 3 Star - 9 L/min rated as per WELS licence number 0046.</p> <ul style="list-style-type: none"> <li>Oval star pattern</li> <li>Size - 115 mm x 175 mm</li> <li>Clear acrylic for 25 mm rail on p. 45</li> </ul>
	HS 020 P-WTC	White/Chrome			
	HS 020 P-WTG	White/Gold			
	HS 020 P-CG	Chrome/Gold			
		Soap Dish			
	SD 025 CL	Clear			
<b>HS 020 J - STREAMJET™ - TRADITIONAL</b>					
	HS 020 J-C	Chrome			<p>Premium 100 mm ABS handpiece with Traditional concentric single pattern jet spray diffusor, giving the most pleasant dense shower.</p>
	HS 020 J-WTC	White/Chrome			
	HS 020 J-WTG	White/Gold			
	HS 020 J-CG	Chrome/Gold			
<b>HS 020 T - STREAMJET™ - TURBO PULSATOR</b>					
	HS 020 T-C	Chrome			<p>Premium 100 mm ABS handpiece, with multiple functions featuring firm concentric jet spray, adjustable through soft zones to Turbo Pulsating action, providing aqua-massage hydrotherapy treatment.</p>
<b>HS 020 X - STREAMJET™ - XL (EXTRA LARGE)</b>					
	HS 020 X-C	Chrome			<p>Premium 130 mm ABS extra large handpiece with Traditional concentric single jet spray diffusor giving a rain-like full pattern spray. All Streamjet® models are supplied with appropriate coloured PVC 1.5 m hose and 700 mm brass tube rail with floating mount brackets. Assembled with 55 mm DR brass wall outlet elbow which features 9 L/min Flow Interchange Spigot and separate licenced dual check/non-return valve to prevent back siphonage. 3 Star - 9 L/min rated as per WELS licence number 0046.</p> <ul style="list-style-type: none"> <li>Oval star pattern</li> <li>Size - 115 mm x 175 mm</li> <li>Clear acrylic for 25 mm rail on p. 45</li> </ul>
		Soap Dish			
	SD 025 CL	Clear			

This product may need future service. Ensure an access panel is installed when fitting to spa baths and tubs.



	Code	Finish	Without GST	With GST	Features
<b>HS 021 C - CHAMPAGNE PULSATOR</b>					
	HS 021 C-C	Chrome			Stylish arched shape ABS handpiece, adjustable from firm spray through soft zones to pulsate-massage and soothing relaxing bubble spray. The Champagne is supplied with appropriate coloured PVC 1.5 m hose and 3 part ABS made Hob Mount set, with parts being a 50 mm bench mount collar for handset support and 26 mm continuous thread and lock nut. Includes a licenced dual check/non return valve. 3 Star - 9 L/min, 2 Star - 12 L/min rated as per WELS licence number 0046.
	HS 021 C-WTC	White/Chrome			
	HS 021 C-WTG	White/Gold			
	HS 021 C-SC	Satin Completely			
	HS 021 C-CG	Chrome/Gold			
	HS 021 C-G	Gold			
					MAKE BENCH HOLE SIZE MAX. 30 mm.
<b>HS 021 P - PRINCESS</b>					
	HS 021 P-C	Chrome			Arched shape performance proven ABS handpiece with single pattern low impact spray with rub-clean corrosion proof diffuser. The Princess is supplied with appropriate coloured PVC 1.5 m hose and 3 part ABS made Hob Mount set, with parts being a 50 mm bench mount collar for handset support and 26 mm continuous thread and lock nut. Includes a licenced dual check/non-return valve. 3 Star - 9 L/min rated as per WELS licence number 0046.
	HS 021 P-ACC	Colour/Chrome			
	HS 021 P-ACG	Colour/Gold			
	HS 021 P-SC	Satin Completely			
	HS 021 P-CG	Chrome/Gold			
	HS 021 P-G	Gold			
					MAKE BENCH HOLE SIZE MAX. 30 mm.
<b>HS 021 J - STREAMJET™</b>					
	HS 021 J-C	Chrome			Light weight arched shape ABS handpiece with traditional pattern firm spray. The Streamjet™ is supplied with appropriate coloured PVC 1.5 m hose and 3 part ABS made Hob Mount set, with parts being a 50 mm bench mount collar for handset support and 26 mm continuous thread and lock nut. Includes a licenced dual check/non-return valve. 3 Star - 9 L/min rated as per WELS licence number 0046.
	HS 021 J-WTC	White/Chrome			
					MAKE BENCH HOLE SIZE MAX. 30 mm.
<b>HS 021 K - KLIPPER</b>					
	HS 021 K-WTC	White/Chrome			Robust design on/off lock function, side lever handpiece with traditional firm pattern spray. The Klipper is supplied with PVC 1.5 m reinforced hose and 3 part ABS made Hob Mount set, with parts being a 50 mm bench mount collar for handset support and 26 mm continuous thread and lock nut. Includes a licenced dual check/non-return valve. 3 Star - 9 L/min rated as per WELS licence number 0046.
					MAKE BENCH HOLE SIZE MAX. 30 mm.

## HOB MOUNT





### HM 019 - HOB MOUNT

	HM 019 C	Chrome			Hob Mount Set, for fitting to basins, spa baths and tubs. Comes with 3 parts, 50 mm benchmount collar, 26 mm continuous thread with lock nut and the appropriate colour PVC hose to suit. <b>Note: A dual check prevention valve is recommended with this item. We suggest model DC 043 on page 43 for in-line connection.</b>
	HM 019 ACC	Colour Chrome			
	HM 019 ACG	Colour Gold			
	HM 019 SC	Satin Completely			
	HM 019 CG	Chrome/Gold			
	HM 019 G	Gold			
					MAKE BENCH HOLE SIZE MAX. 30 mm.







# PADDINGTON - TWIN WATERS COMBINATION

Twin outlet shower system for those persons requiring an overhead and handheld shower combination.  
For 15 L/min and 12 L/min, purchase a Flow Interchange Spigot on p. 42.



	Code	Finish	Without GST	With GST	Features
<b>TW 025 PC - PADDINGTON/CHAMPAGNE PULSATOR</b>					
 <p>C.</p>	TW 025 PC-C	Chrome			<ul style="list-style-type: none"> <li>• Paddington 90 mm domed shower</li> <li>• Champagne multi function pulsating hand shower</li> <li>• Silverflex PVC 1.5 m hose</li> <li>• 800 mm brass friction slide rail</li> <li>• 345 mm swivel swan neck arm</li> <li>• Diverter switchcock valve</li> <li>• 9 L/min Flow Interchange Spigot</li> <li>• Licenced dual check/non-return valve</li> <li>• Overall height 1240 mm</li> </ul>
					3 Star - 9 L/min and 2 Star - 12 L/min rated as per WELS licence number 0046.
	SD 025 CL	Soap Dish Clear			<ul style="list-style-type: none"> <li>• Oval star pattern</li> <li>• Size - 115 mm x 175 mm</li> <li>• Clear acrylic for 25 mm rail on p. 45</li> </ul>
<b>TW 025 PZ - PADDINGTON/BREEZE PULSATOR</b>					
 <p>Z.</p>	TW 025 PZ-C	Chrome			<ul style="list-style-type: none"> <li>• Paddington 90 mm domed shower</li> <li>• Breeze multi function pulsating hand shower</li> <li>• Silverflex PVC 1.5 m hose</li> <li>• 800 mm brass friction slide rail</li> <li>• 345 mm swivel swan neck arm</li> <li>• Diverter switchcock valve</li> <li>• 9 L/min Flow Interchange Spigot</li> <li>• Licenced dual check/non-return valve</li> <li>• Overall height 1240 mm</li> </ul>
					3 Star - 9 L/min rated as per WELS licence number 0046.
	SD 025 CL	Soap Dish Clear			<ul style="list-style-type: none"> <li>• Oval star pattern</li> <li>• Size - 115 mm x 175 mm</li> <li>• Clear acrylic for 25 mm rail on p. 45</li> </ul>
<b>TW 025 PH - PADDINGTON/HERITAGE</b>					
 <p>H.</p>	TW 025 PH-C	Chrome			<ul style="list-style-type: none"> <li>• Paddington 90 mm domed shower</li> <li>• Heritage hand shower</li> <li>• Silverflex PVC 1.5 m hose</li> <li>• 800 mm brass friction slide rail</li> <li>• 345 mm swivel swan neck arm</li> <li>• Diverter switchcock valve</li> <li>• 9 L/min Flow Interchange Spigot</li> <li>• Licenced dual check/non-return valve</li> <li>• Overall height 1240 mm</li> </ul>
					3 Star - 9 L/min rated as per WELS licence number 0046.
	SD 025 CL	Soap Dish Clear			<ul style="list-style-type: none"> <li>• Oval star pattern</li> <li>• Size - 115 mm x 175 mm</li> <li>• Clear acrylic for 25 mm rail on p. 45</li> </ul>
<b>TW 025 PP - PADDINGTON/PRINCESS</b>					
 <p>P.</p>	TW 025 PP-C	Chrome			<ul style="list-style-type: none"> <li>• Paddington 90 mm domed shower</li> <li>• Princess hand shower</li> <li>• Silverflex PVC 1.5 m hose</li> <li>• 800 mm brass friction slide rail</li> <li>• 345 mm swivel swan neck arm</li> <li>• Diverter switchcock valve</li> <li>• 9 L/min Flow Interchange Spigot</li> <li>• Licenced dual check/non-return valve</li> <li>• Overall height 1240 mm</li> </ul>
					3 Star - 9 L/min rated as per WELS licence number 0046.
	SD 025 CL	Soap Dish Clear			<ul style="list-style-type: none"> <li>• Oval star pattern</li> <li>• Size - 115 mm x 175 mm</li> <li>• Clear acrylic for 25 mm rail on p. 45</li> </ul>



	Code	Finish	Without GST	With GST	Features	
<b>TW 025 CC - COSMIC/CHAMPAGNE PULSATOR</b>						
	TW 025 CC-C	Chrome			<ul style="list-style-type: none"> <li>• COSMIC 220 mm x 15 mm rain maker shower</li> <li>• With rub-clean feature</li> <li>• Champagne multi function pulsating hand shower</li> <li>• Silverflex® PVC 1.5 m smooth hose</li> <li>• 800 mm x 25 mm brass friction slide rail</li> <li>• 345 mm extended swivel neck arm</li> <li>• Diverter switchcock valve</li> <li>• 9 L/min Flow Interchange Spigot</li> <li>• Licenced dual check/non-return valve</li> <li>• Overall height 1240 mm</li> </ul>	
		Soap Dish			3 Star - 9 L/min and 2 Star 12 L/min rated, as per WELS licence number 0046.  <ul style="list-style-type: none"> <li>• Oval star pattern</li> <li>• Size - 115 mm x 175 mm</li> <li>• Clear acrylic for 25 mm rail on p. 45</li> </ul>	
	SD 025 CL	Clear				
<b>TW 025 CZ - COSMIC/BREEZE PULSATOR</b>						
	TW 025 CZ-C	Chrome			<ul style="list-style-type: none"> <li>• COSMIC 220 mm x 15 mm rain maker shower</li> <li>• With rub-clean feature</li> <li>• Breeze multi function pulsating hand shower</li> <li>• Silverflex® PVC 1.5 m smooth hose</li> <li>• 800 mm x 25 mm brass friction slide rail</li> <li>• 345 mm extended swivel neck arm</li> <li>• Diverter switchcock valve</li> <li>• 9 L/min Flow Interchange Spigot</li> <li>• Licenced dual check/non-return valve</li> <li>• Overall height 1240 mm</li> </ul>	
		Soap Dish			3 Star - 9 L/min and 2 Star 12 L/min rated, as per WELS licence number 0046.  <ul style="list-style-type: none"> <li>• Oval star pattern</li> <li>• Size - 115 mm x 175 mm</li> <li>• Clear acrylic for 25 mm rail on p. 45</li> </ul>	
	SD 025 CL	Clear				
<b>TW 025 CP - COSMIC/PRINCESS</b>						
	TW 025 CP-C	Chrome			<ul style="list-style-type: none"> <li>• COSMIC 220 mm x 15 mm rain maker shower</li> <li>• With rub-clean feature</li> <li>• Princess hand shower</li> <li>• Silverflex® PVC 1.5 m smooth hose</li> <li>• 800 mm x 25 mm brass friction slide rail</li> <li>• 345 mm extended swivel neck arm</li> <li>• Diverter switchcock valve</li> <li>• 9 L/min Flow Interchange Spigot</li> <li>• Licenced dual check/non-return valve</li> <li>• Overall height 1240 mm</li> </ul>	
		Soap Dish			3 Star - 9 L/min and 2 Star 12 L/min rated, as per WELS licence number 0046.  <ul style="list-style-type: none"> <li>• Oval star pattern</li> <li>• Size - 115 mm x 175 mm</li> <li>• Clear acrylic for 25 mm rail on p. 45</li> </ul>	
	SD 025 CL	Clear				
<b>TW 025 CJ - COSMIC/STREAMJET™ TRADITIONAL</b>						
	TW 025 CJ-C	Chrome			<ul style="list-style-type: none"> <li>• COSMIC 220 mm x 15 mm rain maker shower</li> <li>• With rub-clean feature</li> <li>• Streamjet™ hand shower</li> <li>• Streamjet™ Turbo multi function pulsating hand shower</li> <li>• Streamjet™ XL (Extra Large) hand shower</li> <li>• Silverflex® PVC 1.5 m smooth hose</li> <li>• 800 mm x 25 mm brass friction slide rail</li> <li>• 345 mm extended swivel neck arm</li> <li>• Diverter switchcock valve</li> <li>• 9 L/min Flow Interchange Spigot</li> <li>• Licenced dual check/non-return valve</li> <li>• Overall height 1240 mm</li> </ul>	
	<b>TW 025 CT - COSMIC/STREAMJE™ TURBO PULSATOR</b>					
	TW 025 CT-C	Chrome			<ul style="list-style-type: none"> <li>• COSMIC 220 mm x 15 mm rain maker shower</li> <li>• With rub-clean feature</li> <li>• Streamjet™ Turbo multi function pulsating hand shower</li> <li>• Streamjet™ XL (Extra Large) hand shower</li> <li>• Silverflex® PVC 1.5 m smooth hose</li> <li>• 800 mm x 25 mm brass friction slide rail</li> <li>• 345 mm extended swivel neck arm</li> <li>• Diverter switchcock valve</li> <li>• 9 L/min Flow Interchange Spigot</li> <li>• Licenced dual check/non-return valve</li> <li>• Overall height 1240 mm</li> </ul>	
	<b>TW 025 CX - COSMIC/STREAMJET™ XL (EXTRA LARGE)</b>					
	TW 025 CX-C	Chrome			<ul style="list-style-type: none"> <li>• COSMIC 220 mm x 15 mm rain maker shower</li> <li>• With rub-clean feature</li> <li>• Streamjet™ Turbo multi function pulsating hand shower</li> <li>• Streamjet™ XL (Extra Large) hand shower</li> <li>• Silverflex® PVC 1.5 m smooth hose</li> <li>• 800 mm x 25 mm brass friction slide rail</li> <li>• 345 mm extended swivel neck arm</li> <li>• Diverter switchcock valve</li> <li>• 9 L/min Flow Interchange Spigot</li> <li>• Licenced dual check/non-return valve</li> <li>• Overall height 1240 mm</li> </ul>	
		Soap Dish			3 Star - 9 L/min and 2 Star 12 L/min rated, as per WELS licence number 0046.  <ul style="list-style-type: none"> <li>• Oval star pattern</li> <li>• Size - 115 mm x 175 mm</li> <li>• Clear acrylic for 25 mm rail on p. 45</li> </ul>	
	SD 025 CL	Clear				





For 15 L/min and 12 L/min, purchase a Flow Interchange Spigot on p. 42



	Code	Finish	Without GST	With GST	Features
<b>TW 029 QQ - QUEWB TWIN WATERS</b>					
	TW 029 QQ-C	Chrome			<ul style="list-style-type: none"> <li>• QUEWB 220 mm x 15 mm rain maker shower</li> <li>• With rub-clean feature</li> <li>• QUEWB square ABS edge hand shower</li> <li>• With rub-clean feature</li> <li>• Silverflex® PVC 1.5 m smooth hose</li> <li>• 800 mm x 25 mm brass friction slide rail</li> <li>• 380 mm extended swivel crane neck arm</li> <li>• Diverter switchcock valve</li> <li>• 9 L/min Flow Interchange Spigot</li> <li>• Licenced dual check/non-return valve</li> <li>• Overall height 1280 mm</li> </ul> <p>3 Star - 9 L/min and 2 Star 12 L/min rated, as per WELS licence number 0046.</p>
	SD 025 CL	Clear			<ul style="list-style-type: none"> <li>• Soap Dish</li> <li>• Oval star pattern</li> <li>• Size - 115 mm x 175 mm</li> <li>• Clear acrylic for 25 mm rail on p. 45</li> </ul>
<b>HS 010 Q - QUEWB SQUARE EDGE/SLIDE RAIL HANDSHOWER</b>					
	HS 010 Q-C	Chrome			<ul style="list-style-type: none"> <li>• QUEWB square edge ABS hand shower</li> <li>• With rub-clean feature</li> <li>• Silverflex® PVC 1.5 m smooth hose</li> <li>• 700 mm square edge slide rail</li> <li>• Square edge friction Slide Track Cradle</li> <li>• Square edge 55 mm wall outlet elbow</li> <li>• 9 L/min Flow Interchange Spigot</li> <li>• Licenced dual check/non-return valve</li> </ul> <p>3 Star - 9 L/min and 2 Star 12 L/min rated, as per WELS licence number 0046.</p>
<b>HS 011 Q - QUEWB SQUARE EDGE HANDSHOWER</b>					
	HS 011 Q-C	Chrome			<ul style="list-style-type: none"> <li>• QUEWB square edge ABS hand shower</li> <li>• With rub-clean feature</li> <li>• Silverflex® PVC 1.5 m smooth hose</li> <li>• Square edge 85 mm wall outlet handset bracket</li> <li>• 9 L/min Flow Interchange Spigot</li> <li>• Licenced dual check/non-return valve</li> </ul> <p>3 Star - 9 L/min and 2 Star 12 L/min rated, as per WELS licence number 0046.</p>

Twin outlet shower system for those persons requiring an overhead and handheld shower combination.  
For 15 L/min and 12 L/min, purchase a Flow Interchange Spigot on p. 42.



	Code	Finish	Without GST	With GST	Features
<b>TW 029 CC - COSMIC/CHAMPAGNE PULSATOR</b>					
	TW 029 CC-C	Chrome			<ul style="list-style-type: none"> <li>• COSMIC 220 mm x 15 mm rain maker shower</li> <li>• With rub-clean feature</li> <li>• Champagne pulsator 3-function handpiece</li> <li>• Silverflex® PVC 1.5 m smooth hose</li> <li>• 800 mm x 25 mm brass friction slide rail</li> <li>• 380 mm extended crane neck arm</li> <li>• Diverter switchcock valve</li> <li>• 9 L/min Flow Interchange Spigot</li> <li>• Licenced dual check/non-return valve</li> <li>• Overall height 1280 mm</li> </ul>
		Soap Dish			
	SD 025 CL	Clear			<ul style="list-style-type: none"> <li>• 3 Star - 9 L/min and 2 Star 12 L/min rated, as per WELS licence number 0046.</li> <li>• Oval star pattern</li> <li>• Size - 115 mm x 175 mm</li> <li>• Clear acrylic for 25 mm rail on p. 45</li> </ul>
<b>TW 029 CZ - COSMIC/BREEZE PULSATOR</b>					
	TW 029 CZ-C	Chrome			<ul style="list-style-type: none"> <li>• COSMIC 220 mm x 15 mm rain maker shower</li> <li>• With rub-clean feature</li> <li>• Breeze pulsator 4-function handpiece</li> <li>• Silverflex® PVC 1.5 m smooth hose</li> <li>• 800 mm x 25 mm brass friction slide rail</li> <li>• 380 mm extended crane neck arm</li> <li>• Diverter switchcock valve</li> <li>• 9 L/min Flow Interchange Spigot</li> <li>• Licenced dual check/non-return valve</li> <li>• Overall height 1280 mm</li> </ul>
		Soap Dish			
	SD 025 CL	Clear			<ul style="list-style-type: none"> <li>• 3 Star - 9 L/min and 2 Star 12 L/min rated, as per WELS licence number 0046.</li> <li>• Oval star pattern</li> <li>• Size - 115 mm x 175 mm</li> <li>• Clear acrylic for 25 mm rail on p. 45</li> </ul>
<b>TW 029 CP - COSMIC/PRINCESS</b>					
	TW 029 CP-C	Chrome			<ul style="list-style-type: none"> <li>• COSMIC 220 mm x 15 mm rain maker shower</li> <li>• With rub-clean feature</li> <li>• Princess handpiece</li> <li>• Silverflex® PVC 1.5 m smooth hose</li> <li>• 800 mm x 25 mm brass friction slide rail</li> <li>• 380 mm extended crane neck arm</li> <li>• Diverter switchcock valve</li> <li>• 9 L/min Flow Interchange Spigot</li> <li>• Licenced dual check/non-return valve</li> <li>• Overall height 1280 mm</li> </ul>
		Soap Dish			
	SD 025 CL	Clear			<ul style="list-style-type: none"> <li>• 3 Star - 9 L/min and 2 Star 12 L/min rated, as per WELS licence number 0046.</li> <li>• Oval star pattern</li> <li>• Size - 115 mm x 175 mm</li> <li>• Clear acrylic for 25 mm rail on p. 45</li> </ul>
<b>TW 029 CJ - COSMIC/STREAMJET™ TRADITIONAL</b>					
	TW 029 CJ-C	Chrome			<ul style="list-style-type: none"> <li>• COSMIC 220 mm x 15 mm rain maker shower</li> <li>• With rub-clean feature</li> <li>• Streamjet™ Traditional handpiece</li> <li>• Streamjet™ Turbo Pulsator handpiece</li> <li>• Streamjet™ XL (Extra Large) handpiece</li> <li>• Silverflex® PVC 1.5 m smooth hose</li> <li>• 800 mm x 25 mm brass friction slide rail</li> <li>• 380 mm extended crane neck arm</li> <li>• Diverter switchcock valve</li> <li>• 9 L/min Flow Interchange Spigot</li> <li>• Licenced dual check/non-return valve</li> <li>• Overall height 1280 mm</li> </ul>
		Soap Dish			
	SD 025 CL	Clear			<ul style="list-style-type: none"> <li>• 3 Star - 9 L/min and 2 Star 12 L/min rated, as per WELS licence number 0046.</li> <li>• Oval star pattern</li> <li>• Size - 115 mm x 175 mm</li> <li>• Clear acrylic for 25 mm rail on p. 45</li> </ul>
<b>TW 029 CT - COSMIC/STREAMJET™ TURBO PULSATOR</b>					
	TW 029 CT-C	Chrome			<ul style="list-style-type: none"> <li>• COSMIC 220 mm x 15 mm rain maker shower</li> <li>• With rub-clean feature</li> <li>• Streamjet™ Turbo Pulsator handpiece</li> <li>• Streamjet™ XL (Extra Large) handpiece</li> <li>• Silverflex® PVC 1.5 m smooth hose</li> <li>• 800 mm x 25 mm brass friction slide rail</li> <li>• 380 mm extended crane neck arm</li> <li>• Diverter switchcock valve</li> <li>• 9 L/min Flow Interchange Spigot</li> <li>• Licenced dual check/non-return valve</li> <li>• Overall height 1280 mm</li> </ul>
<b>TW 029 CX - COSMIC/STREAMJET™ XL (EXTRA LARGE)</b>					
	TW 029 CX-C	Chrome			<ul style="list-style-type: none"> <li>• COSMIC 220 mm x 15 mm rain maker shower</li> <li>• With rub-clean feature</li> <li>• Streamjet™ XL (Extra Large) handpiece</li> <li>• Silverflex® PVC 1.5 m smooth hose</li> <li>• 800 mm x 25 mm brass friction slide rail</li> <li>• 380 mm extended crane neck arm</li> <li>• Diverter switchcock valve</li> <li>• 9 L/min Flow Interchange Spigot</li> <li>• Licenced dual check/non-return valve</li> <li>• Overall height 1280 mm</li> </ul>
		Soap Dish			
SD 025 CL	Clear			<ul style="list-style-type: none"> <li>• 3 Star - 9 L/min and 2 Star 12 L/min rated, as per WELS licence number 0046.</li> <li>• Oval star pattern</li> <li>• Size - 115 mm x 175 mm</li> <li>• Clear acrylic for 25 mm rail on p. 45</li> </ul>	



Note: We can make PVC hoses to any length.

Code	Hose Length	Finish	Without GST	With GST	Features
<b>CHROME SOFTFLEX® SPIRAL HOSE - PVC</b>					
SH 900 C	900 mm	Chrome			Handheld shower hose with elastic inner, supported by polyester cords and nylon, wrapped in chrome metallic band with a clear PVC outer sheath. Conical end nuts chrome plated brass ½" BSP female threaded.
SH 012 C	1200 mm	Chrome			
SH 015 C	1500 mm	Chrome			
SH 020 C	2000 mm	Chrome			
SH 030 C	3000 mm	Chrome			
SH 035 C	3500 mm	Chrome			
<b>COLOUR/CHROME SOFTFLEX® SPIRAL HOSE - PVC</b>					
SH 015 WTC	1500 mm	White/Chrome			Handheld shower hose with elastic inner, supported by polyester cords and nylon with appropriate coloured PVC outer sheath. Conical end nuts either chrome or gold plated brass, ½" BSP female threaded.
SH 015 IVC	1500 mm	Ivory/Chrome			
SH 015 BLC	1500 mm	Black/Chrome			
SH 015 BUC	1500 mm	Burgundy/Chrome			
SH 015 GRC	1500 mm	Hawthorn Green/Chrome			
SH 020 WTC	2000 mm	White/Chrome			
SH 020 IVC	2000 mm	Ivory/Chrome			
<b>COLOUR/GOLD SOFTFLEX® SPIRAL HOSE - PVC</b>					
SH 015 WTG	1500 mm	White/Gold			Handheld shower hose with elastic inner, supported by polyester cords and nylon wrapped in gold metalised band with a clear PVC outer sheath. Conical end nuts gold plated brass, ½" BSP female threaded.
SH 015 IVG	1500 mm	Ivory/Gold			
SH 015 BLG	1500 mm	Black/Gold			
SH 015 BUG	1500 mm	Burgundy/Gold			
SH 015 GRG	1500 mm	Hawthorn Green/Gold			
SH 015 CG	1500 mm	Chrome/Gold			
SH 020 WTG	2000 mm	White/Gold			
SH 020 IVG	2000 mm	Ivory/Gold			
SH 020 CG	2000 mm	Chrome/Gold			
<b>GOLD SOFTFLEX® SPIRAL HOSE - PVC</b>					
SH 015 G	1500 mm	Gold			Handheld shower hose with elastic inner, supported by polyester cords and nylon wrapped in gold metalised band with a clear PVC outer sheath. Conical end nuts gold plated brass, ½" BSP female threaded.
SH 020 G	2000 mm	Gold			
<b>SILVERFLEX® SMOOTH SURFACE HOSE - PVC</b>					
SH 015 CS	1500 mm	Chrome Silverflex®			Hose of elastic Chrome PVC encased in a smooth sheath. Conical end nuts chrome plated brass ½" BSP female threaded.
SH 020 CS	2000 mm	Chrome Silverflex®			
<b>SATIN CHROME SOFTFLEX® SPIRAL HOSE - PVC</b>					
SH 015 SC	1500 mm	Satin Completely			Hose with elastic inner, supported by polyester and nylon. Satin Chrome wrapped in spiral metallic band. Conical end nuts satin plated brass, ½" BSP female threaded.
SH 020 SC	2000 mm	Satin Completely			
<b>REINFORCED SOFTFLEX® SMOOTH SURFACE HOSE - PVC</b>					
SH 900 WR	900 mm	White			Reinforced hose of elastic PVC. Strengthened by polyester woven cords, encased in a smooth sheath. Conical end nuts chrome plated brass ½" BSP female threaded.
SH 012 WR	1200 mm	White			
SH 015 WR	1500 mm	White			
SH 020 WR	2000 mm	White			
SH 030 WR	3000 mm	White			
SH 035 WR	3500 mm	White			
<b>HIGH PRESSURE SOFTFLEX® SMOOTH SURFACE HOSE - PVC</b>					
SH 900 HP	900 mm	Black/Silver Braid			Heavy duty hose designed to handle maximum 700kPa (100 psi) at a maximum temperature of 55°C. Reinforced black elastic PVC strengthened by silver polyester woven cords and nylon wrapped in a smooth sheath. Conical end nuts chrome plated brass, ½" BSP female threaded.
SH 012 HP	1200 mm	Black/Silver Braid			
SH 015 HP	1500 mm	Black/Silver Braid			
SH 020 HP	2000 mm	Black/Silver Braid			
SH 030 HP	3000 mm	Black/Silver Braid			
SH 035 HP	3500 mm	Black/Silver Braid			
SH 040 HP	4000 mm	Black/Silver Braid			



## GREAT NEWS!

With the exception of some outdated colours, all PVC hoses can be made by Con-Serv to any length.

For extra length add \$1.00 per 100 mm.  
For less, deduct \$1.00 per 100 mm.

**PLEASE NOTE:** Credit requests will not be considered for shower hoses manufactured to a requested specific length outside the models listed.











	Code	Hose Length	Finish	Without GST	With GST	Features
<b>METAL HOSE - DOUBLE AGRAFF</b>						
	SH 015 HD	1500 mm	Chrome			Heavy duty, metal double Agraff handheld shower hose with elastic inner supported by brass outer casing. Conical end nuts 1/2" BSP female threaded.
	SH 015 SCM	1500 mm	Satin Completely			
	SH 015 B	1500 mm	Brass			
	SH 015 GM	1500 mm	Gold			
	SH 020 HD	2000 mm	Chrome			
	SH 020 GM	2000 mm	Gold			
<b>QUICK RELEASE HOSE COUPLING WITH DRY-BREAK STOP VALVE</b>						
<p>1/2" Female inlet connects to wall outlet</p> <p>1/2" Male outlet connects to hose</p>	QR 027 DB	55 mm	Chrome			<p>Chrome plated brass fitting. 1/2" female to inlet to 1/2" male outlet. Incorporating stop valve to allow handheld shower hose to be removed and water supply to be sealed off at the wall supply elbow.</p> <p>Working pressure: MAX. 25 Bar Water Temperature: MAX. 80°C</p>
<b>PVC SHOWER HOSE - BULK</b>						
	SH 027 CH	25 m	Chrome - Softflex®			Handheld shower hose with elastic inner supported by polyester cords and nylon with appropriate coloured PVC outer sheath.
	SH 027 WT	25 m	White - Softflex®			
	SH 027 WR	25 m	Reinforced Smooth - White			
	SH 027 HP	25 m	Hi Pressure - Black/Silver Braid			
<b>HOSE REPAIR TOOLS</b>						
	SH 027 HT		Hose Handvice tool			<p>Polyethylene Polyethylene-Steel 6 mm key</p> <p>The hose Handvice Tool was engineered, developed and manufactured in Australia and is an invention by Con-Serv. The tool grips, the hose, and hose end sleeve making it possible to repair 14 mm and 15 mm shower hoses.</p> <p>PATENT NUMBER 2002301716</p>
	SH 027 AK		6mm Allen key "T" tool			
<b>TRADESMAN HOSE REPAIR KIT</b>						
	SH 027 TR		Kit			The Tradesman Eel Grip Seal shower hose repair kit contains all tools, aids and the necessary spare part items with instructions for use to repair 25 PVC 14 mm and 15 mm shower hoses.
<b>EEL GRIP SEAL HOSE REPAIR SPARE PARTS - BULK PACKS</b>						
	SH 027 SY	25	Eel grip seals - Delrin	Yellow		<p>EEL GRIP SEAL</p>
	SH 027 HW	50	Washers - Nitril N70	White		
	SH 027 HS	18	14 mm Hose sleeves	Chrome		
	SH 027 OS	7	15 mm Hose sleeves	Chrome		
	SH 027 CN	5	Conical end nuts	Chrome		
	SH 027 GS	5	Hose sleeves	OZ Gold		
	SH 027 GN	5	Conical end nuts	OZ Gold		
	SH 027 LG	1	Tube lanolin grease			
	SH 027 MS	1	Measure tape			
	SH 027 TK	1	Trimming knife			









# HANDPIECES - PERFORMANCE PROVEN

All Con-Serv handpieces are zero star rated. Handpieces that provide restriction at the head, subjects the flexible hose to back pressure. This shortens hose life and can even lead to the handpiece being dislodged from its mounting by the tendency of the hose to straighten out under pressure, causing damage to the handpiece or indeed the user.

	Code	Finish	Without GST	With GST	Features	
<b>HP 025 KLIPPER - ON/OFF SIDE LEVER</b>						
	HP 025 WT	White			Robust designed on/off lock function, side lever ABS handpiece. Simple finger tip lever control with traditional firm pattern, easy clean spray diffuser. Available in white only.  <b>NOT TO BE USED AS LINE END STOP CONTROL. COULD CAUSE THERMAL SHOCK.</b>	
<b>HP 028 HERITAGE</b>						
	HP 028 C	Chrome			Traditional stylish 60 mm pressed brass shower rose, 1/2" thread mounted to a brass handpiece tube with stylish brass hand grip.	
	HP 028 ACC	Colour/Chrome				
	HP 028 ACG	Colour/Gold				
	HP 028 G	Gold				
<b>HP 031 CHAMPAGNE-PULSATOR</b>						
	HP 031 C	Chrome			Stylish arched shape ABS handpiece, adjustable from firm spray through soft zones to pulsate-massage and soothing, relaxing bubble spray.	
	HP 031 WT	White				
	HP 031 WTG	White/Gold				
	HP 031 SC	Satin Completely				
	HP 031 CG	Chrome/Gold				
	HP 031 G	Gold				
<b>HP 034 PRINCESS</b>						
	HP 034 C	Chrome			Arched shape performance proven ABS handpiece with wide single pattern low impact spray and rub-clean corrosion proof spray diffuser.	
	HP 034 AC	Colour				
	HP 034 SC	Satin Completely				
	HP 034 G	Gold				
<b>HP 036 HOSFAB</b>						
	HP 036 C	Chrome			Lightweight ABS handpiece with traditional pattern firm spray. Removable easy clean spray diffuser. Available in chrome and white only.	
	HP 036 WT	White				
<b>HP 037 BREEZE - PULSATOR</b>						
	HP 037 C	Chrome			Stylish arched shape ABS handpiece adjustable from firm spray through soft zones to pulsate-massage.	
	HP 037 WT	White				
<b>HP 038 STREAMJET™</b>						
	HP 038 C	Chrome			Premium ABS 100 mm shower handpiece with traditional concentric single pattern jet spray diffuser producing a generous full pattern band of spray circles giving the most pleasant and effective dense shower.	
	HP 038 WT	White				
	For Streamjet™ Turbo and Streamjet™ XL prices, refer to page 19.					
<b>HP 039 SLENDER - TURBO PULSATOR</b>						
	HP 039 C	Chrome			Conventional performance proven strong ABS handpiece. Adjustable from firm spray through soft zones to pulsate-massage turbo jet.	
	HP 039 WTC	White/Chrome				
	HP 039 IVG	Ivory/Gold				
<b>HP 041 QUEWB</b>						
	HP 041 C	Chrome			Square shaped ABS handpiece with single pattern low impact spray.	

Con-Serv wall elbow and security brackets have non-return facilities as per Watermark Licence 2696. This removes the possibility of a handheld shower being the source of back siphonage contamination to the water supply should it be immersed in bath or other vessel when the supply system is depressurised. All Con-Serv handheld shower kits offer this feature regardless of the domestic or commercial application.



	Code	Finish	Without GST	With GST	Features
<b>EB 045 - WALL OUTLET ELBOW WITH DUAL CHECK VALVE</b>					
	EB 045 C	Chrome			50 mm DR brass wall outlet elbow features 9 L/min flow regulation and separate licenced dual check/non-return to prevent back siphonage. Available flow rates 12, 15 L/min and full flow.
	EB 045 WT	White			
					Watermark applies to dual check valve only.
<b>EB 046 - WALL OUTLET ELBOW WITH DUAL CHECK VALVE</b>					
	EB 046 C	Chrome			55 mm DR brass wall outlet elbow features 9 L/min Flow Interchange Spigot and separate licenced dual check/non-return valve to prevent back siphonage. The elbow body employs a grub screw locking system and is fastened to the 1/2" connecting spigot. Available flow rates 12, 15 L/min and full flow. Supplied with 57 mm solid brass flat flange.
	EB 046 ACC	Colour/Chrome			
	EB 046 ACG	Colour/Gold			
	EB 046 SC	Satin Completely			
	EB 046 PB	Polished Brass			
	EB 046 CG	Chrome/Gold			
	EB 046 G	Gold			
					Watermark applies to dual check valve only.
<b>EB 073 - WALL OUTLET ELBOW BRACKET WITH DUAL CHECK VALVE</b>					
	EB 073 C	Chrome			85 mm DR brass right angled wall outlet handset bracket features a 9 L/min Flow Interchange Spigot and separate licenced dual check/non-return valve to prevent back siphonage. The elbow body employs a grub screw locking system and is fastened to the 1/2" connecting spigot. Available flow rates 12, 15 L/min and full flow.
	EB 073 ACC	Colour/Chrome			
	EB 073 ACG	Colour/Gold			
	EB 073 SC	Satin Completely			
	EB 073 PB	Polished Brass			
	EB 073 CG	Chrome/Gold			
	EB 073 G	Gold			
					Supplied with 57 mm solid brass flat flange. Watermark applies to dual check valve only.
<b>EB 074 - WALL MOUNT HANDSET BRACKET</b>					
	EB 074 C	Chrome			85 mm DR brass right angled wall mount bracket. The bracket body with tapered 'C' hook to engage conical end nut of hose employs a grub screw, damage resistant locking system and is fastened to a separate brass dual screw wall mount back plate. Stainless steel screws supplied.
	EB 074 ACC	Colour/Chrome			
	EB 074 ACG	Colour/Gold			
	EB 074 SC	Satin Completely			
	EB 074 PB	Polished Brass			
	EB 074 CG	Chrome/Gold			
	EB 074 G	Gold			
<b>EB 075 - SQUARE-EDGE WALL OUTLET ELBOW WITH DUAL CHECK VALVE</b>					
	EB 075 C	Chrome			Square-Edge 55 mm DR brass wall outlet elbow features 9 L/min Flow Interchange Spigot and separate licenced dual check/non-return valve to prevent back siphonage. The elbow body employs a grub screw locking system and is fastened to the 1/2" connecting spigot. Available flow rates 12, 15 L/min and full flow. Supplied with 57 mm solid brass flat flange.
					Watermark applies to dual check valve only.
<b>EB 076 - SQUARE-EDGE WALL OUTLET ELBOW BRACKET WITH DUAL CHECK VALVE</b>					
	EB 076 C	Chrome			Square-Edge 85 mm DR brass right angled wall outlet handset bracket features a 9 L/min Flow Interchange Spigot and separate licenced dual check/non-return valve to prevent back siphonage. The elbow body employs a grub screw locking system and is fastened to the 1/2" connecting spigot. Available flow rates 12, 15 L/min and full flow. Supplied with 57 mm solid brass flat flange.
					Watermark applies to dual check valve only.
<b>EB 085 - WALL MOUNT ABS HANDSET BRACKET</b>					
	EB 085 C	Chrome			Fixed ABS 70 mm handpiece wall mount support bracket. Not adjustable. Dual screw fixing. Stainless steel screws supplied.

# SLIDE-RAIL OPTIONS

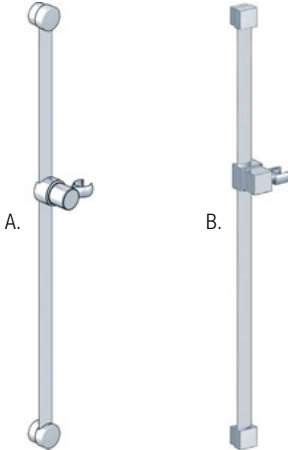
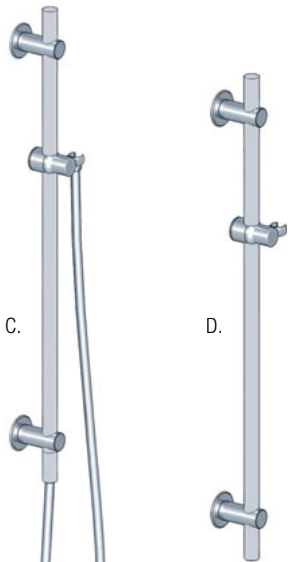
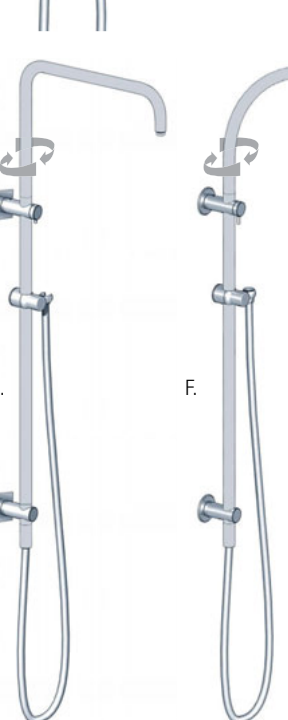
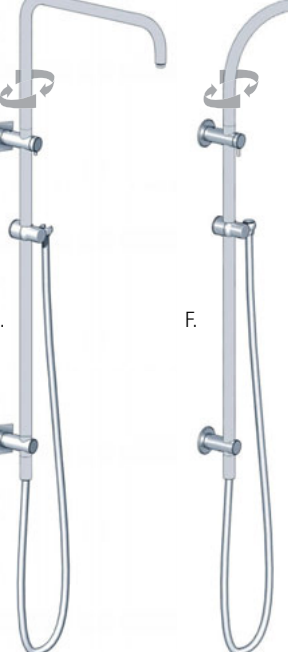
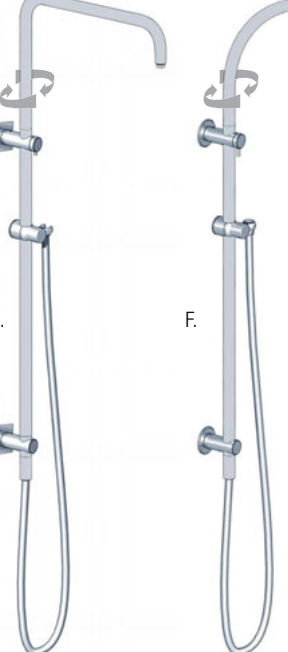
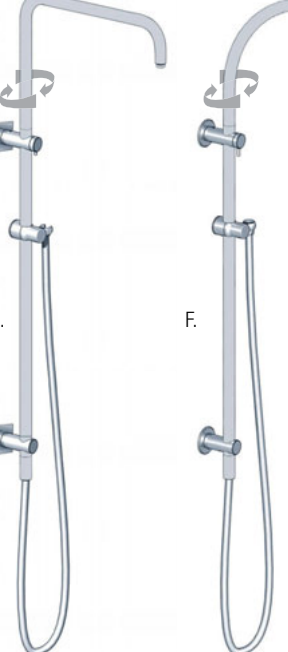

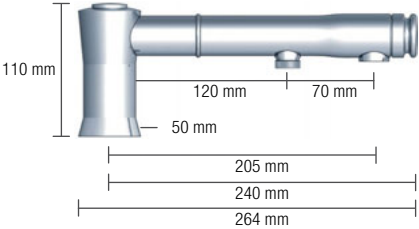
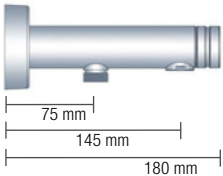
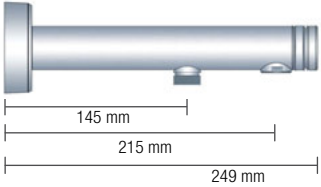

The Friction Slide Handset Support Cradle on these rails are designed especially for those persons with weakend wrists, arthritic and grip problems. When exhibited in a dry area, (such as a showroom), the spring tensioned Nylon Wearing Liner inside the cradle will grip to the rail and will be hard to move. Once the rail is installed in a moist environment, (such as a bathroom), the liner will adjust and allow a smooth and positive movement. THIS WE PROMISE.

	Code	Finish	Without GST	With GST	Features
<b>SR 010 - CRYSTAL SLIDE RAIL (A)</b>					
	SR 010 C	Chrome			Solid brass 700 mm Ø to Ø slide track with integrated handset support bracket cradle and tapered 'C' hook to engage conical end nut of hose. Supplied complete with brass end mount tubes and cover caps. The friction slide design with wearing liner is most suitable for those persons with weakened wrists, arthritic and grip problems.  304 Stainless steel fixing screws supplied.  <b>SPECIAL LENGTHS MADE TO ORDER.</b>
	SR 010 ACC	Colour/Chrome			
	SR 010 ACG	Colour/Gold			
	SR 010 SC	Satin Completely			
	SR 010 CG	Chrome/Gold			
	SR 010 G	Gold			
<b>SR 028 - QUEWB SLIDE RAIL (B)</b>					
	SR 028 C	Chrome			Square-Edge Solid brass 700 mm Ø to Ø slide track with integrated handset support bracket cradle and tapered 'C' hook to engage conical end nut of hose. Supplied complete with brass end mount tubes and cover caps. The friction slide design with wearing liner is most suitable for those persons with weakened wrists, arthritic and grip problems.  304 Stainless fixing screws supplied.
<b>SR 026 - RIVIERA SLIDE RAIL (C)</b>					
	SR 026 C	Chrome			Prestige, modern 800 mm brass Ø to Ø brass friction slide rail with top bracket integrated wall outlet connection which features a 9 L/min Flow Interchange Spigot, a 1.5 m Silverflex® hose with separate licenced dual check non-return valve to prevent back siphonage. Available flow rates 12, 15 L/min and full flow.  304 Stainless fixing screws supplied.
		Spare part			
		Special make hose			
	SH 015 TW	Chrome Silverflex®			
<b>SR 020 - POLAR SLIDE RAIL (D)</b>					
	SR 020 C	Chrome			Round brass tube 700 mm Ø to Ø by 25 mm rail with brass handset support bracket cradle and 50 mm screw on flange cover. Supplied with 57 mm solid brass flat flanges.  304 Stainless steel fixing screws supplied.
	SR 020 WTC	White/Chrome			
	SR 020 WTG	White/Gold			
	SR 020 IVC	Ivory/Chrome			
	SR 020 IVG	Ivory/Gold			
	SR 020 CG	Chrome/Gold			
<b>SR 029 - CRANE NECK TWIN WATERS SLIDE RAIL (E)</b>					
	SR 029 C	Chrome			Prestige modern 800 mm Ø to Ø brass friction slide rail with 380 mm swivel crane neck arm extension, 1.5 m Silverflex® hose and ½" BSP wall outlet diverter switchcock valve for overhead or handheld shower selections. The slide rail wall outlet features a 9 L/min Flow Interchange Spigot and separate licenced dual check non-return valve to prevent back siphonage. Available flow rates 12, 15 L/min and full flow.  304 Stainless fixing screws supplied.
		Spare part			
		Special make hose			
	SH 015 TW	Chrome Silverflex®			
<b>SR 025 - SWAN NECK TWIN WATERS SLIDE RAIL (F)</b>					
	SR 025 C	Chrome			Prestige, modern 800 mm Ø to Ø brass friction slide rail with 345 mm swivel swan neck arm extension, 1.5 m Silverflex® hose and ½" BSP wall outlet diverter switchcock valve for overhead or handheld shower selections. The slide rail wall outlet features a 9 L/min Flow Interchange Spigot and separate licenced dual check non-return valve to prevent back siphonage. Available flow rates 12, 15 L/min and full flow.
		Spare part			
		Special make hose			
	SH 015 TW	Chrome Silverflex®			

Stylish LONG-REACH diverter with PULL-TWIST dual function button control for high to very low water pressures. Solid brass construction. All models will suit most baths or spa bath applications.

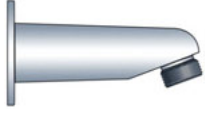

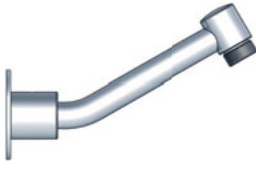
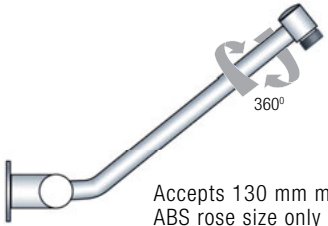







	Code	Finish	Without GST	With GST	Features
<b>DV 021 - SWITCHCOCK VALVE</b>					
	DV 021 C	Chrome			Brass made two-way switch cock diverter valve with ½" BSP female threaded inlet connection to wall and two ½" BSP male threaded outlets. Turn lever handle to select outlet on axis of mounting thread or outlet perpendicular to the axis. Suitable for installation where a choice is required for use of a fixed overhead shower and a handheld shower on a flexible hose.
	DV 021 ACC	Colour/Chrome			
	DV 021 ACG	Colour/Gold			
	DV 021 SC	Satin Completely			
	DV 021 CG	Chrome Gold			
	DV 021 G	Gold			
<b>DV 067 - HOB MOUNT LONG-REACH BATH DIVERTER</b>					
	DV 067 C	Chrome			Brass made 205 mm swing-away Hob Mount Diverter spout with Pull-Twist dual function front button control anti-splash ½" aerator. Supplied with ½" female swivel mount for connection to Hob base body. Most suitable for high to very low water pressures.
	DV 067 ACC	Colour/Chrome			
	DV 067 ACG	Colour/Gold			
	DV 067 SC	Satin Completely			
	DV 067 CG	Chrome Gold			
	DV 067 G	Gold			
<b>DV 068 - LONG-REACH BATH DIVERTER</b>					
	DV 068 C	Chrome			Brass made, 145 mm from wall to centre of aerator, bath diverter spout with PULL-TWIST dual function, front button control and anti-splash ½" aerator. Supplied with ¾" female connection to water outlet with ½" F x ¾" M. Reducing bush supplied. A 65 mm domed flange is provided. Most suitable for high to very low water pressures. Upon request, diverter is available with dual check back flow valve to prevent back syphonage.
	DV 068 ACC	Colour/Chrome			
	DV 068 ACG	Colour/Gold			
	DV 068 SC	Satin Completely			
	DV 068 CG	Chrome Gold			
	DV 068 G	Gold			
<b>DV 069 - EXTENDED LONG-REACH BATH DIVERTER</b>					
	DV 069 C	Chrome			Brass made, 215 mm from wall to centre of aerator bath diverter spout with PULL-TWIST dual function, front button control and anti-splash ½" aerator. Supplied with ¾" female connection to water outlet with ½" F x ¾" M. Reducing bush supplied. A 65 mm domed flange is provided. Most suitable for high to very low water pressures. Upon request, diverter is available with dual check back flow valve to prevent back syphonage.
	DV 069 ACC	Colour/Chrome			
	DV 069 ACG	Colour/Gold			
	DV 069 SC	Satin Completely			
	DV 069 CG	Chrome Gold			
	DV 069 G	Gold			
<b>DV 070 - HOB BASE UPSTAND</b>					
	DV 070 C	Chrome			An optional extra where greater clearance is required for the Hob Mount Bath Diverter to clear bath lip. 25 mm brass made with 38/3 N70 nitrile 'O' ring seal.
	DV 070 SC	Satin Completely			
	DV 070 G	Gold			











All Con-Serv® shower arm attachments are sold NON WATER SAVING (NWS). Con-Serv's Water Efficiency licence number 0046 only covers arm and tested shower rose combinations.

	Code	Finish	Without GST	With GST	Features
<b>SA 005 - 55 mm FIXED ARM</b>					
	SA 005 C	Chrome			55 mm x 20° brass limited projection fixed arm. A ½" BSP spigot screws onto the wall outlet. The arm encapsulates the spigot and is fastened by grub screw for final connection. Supplied with 57 mm flat flange.
	SA 005 AC	Colour			
	SA 005 ACG	Colour/Gold			
	SA 005 SC	Satin Completely			
	SA 005 CG	Chrome/Gold			
	SA 005 G	Gold			
<b>SA 100 - 100 mm FIXED ARM</b>					
	SA 100 C	Chrome			100 mm x 20° brass fixed arm. A ½" BSP spigot screws onto the wall outlet. The arm encapsulates the spigot and is fastened by grub screw for final connection. Supplied with 57 mm flat flange.
	SA 100 AC	Colour			
	SA 100 ACG	Colour/Gold			
	SA 100 SC	Satin Completely			
	SA 100 CG	Chrome/Gold			
	SA 100 G	Gold			
<b>SA 165 - 165 mm GRAND STYLE ARM</b>					
	SA 165 C	Chrome			Standard brass 165 mm upswept style fixed arm. ½" BSP female connection to wall outlet ½" BSP male thread for shower connection. Does not require a wall flange.
	SA 165 AC	Colour			
	SA 165 SC	Satin Completely			
	SA 165 G	Gold			
<b>SA 030 - 150 mm UPSWEPT FIXED ARM</b>					
	SA 030 C	Chrome			150 mm ½" M&F brass upswept fixed arm. A ½" BSP spigot screws onto the wall outlet. The arm encapsulates the spigot and is fastened by grub screw for final connection. Supplied with 57 mm flat flange.
	SA 030 AC	Colour			
	SA 030 ACG	Colour/Gold			
	SA 030 SC	Satin Completely			
	SA 030 CG	Chrome/Gold			
	SA 030 G	Gold			
<b>SA 060 - 300 mm CLICKLOCK™ ADJUSTABLE/ORBITAL ARM</b>					
 Accepts 130 mm maximum ABS rose size only	SA 060 C	Chrome			300 mm ½" M & F brass upswept adjustable arm with anti-droop Clicklock™ elbow mechanism. The arm adjusts vertically and orbits 360° at the outlet. A ½" BSP spigot screws onto the wall outlet. The arm elbow encapsulates the spigot and is fastened by grub screw for final connection. Supplied with 57 mm chromed brass wall flange.
	SA 060 ACC	Colour/Chrome			
	SA 060 ACG	Colour/Gold			
	SA 060 SC	Satin Completely			
	SA 060 CG	Chrome/Gold			
	SA 060 G	Gold			
	SP 063	Adjustable arm olive			
<b>SA 070 - 260 mm ADJUSTABLE ARM</b>					
	SA 070 C	Chrome			260 mm ½" M&F upswept Hi-style single joint adjustable arm, tensioned with a nylon grip olive seal. ½" BSP adjustable connection to wall outlet, ½" BSP male outlet for shower connection. Supplied with domed flange.
	SA 070 WTC	White/Chrome			
	SA 070 WTG	White/Gold			
	Spare Part -	Adjustable arm olive			
	SP 063	2 pack			
<b>SA 090 - 290 mm SWAN NECK ARM</b>					
	SA 090 C	Chrome			290 mm ½" M&F fixed brass swan neck arm. The outlet height of the arm is 225 mm above the wall outlet and projects the shower 200 mm from the wall. A ½" BSP spigot screws onto the wall outlet. The arm encapsulates the spigot and is fastened by grub screw for final connection. Supplied with 57 mm flat flange.
	SA 090 AC	Colour			
	SA 090 ACG	Colour/Gold			
	SA 090 SC	Satin Completely			
	SA 090 PB	Polished Brass			
	SA 090 CG	Chrome/Gold			
	SA 090 G	Gold			
				<b>MOST SUITABLE FOR GRAVITY FED SHOWER APPLICATIONS</b>	



	Code	Finish	Without GST	With GST	Features
<b>SA 380 - SWIVEL CRANE NECK ARM</b>					
	SA 380 C	Chrome			330 mm ½" M & F brass swivel crane neck arm. The arm increases the height of the shower rose 250 mm above the wall outlet and projects the shower rose 380 mm from the wall. Most suitable for installations where shower height is required above wall outlet.
	SA 380 G	Gold			
<b>SA 140 - 140 mm SWIVEL CRANE NECK ARM</b>					
	SA 140 C	Chrome			140 mm Low Rise Swivel Crane Neck Arm. For installations where 330 mm Crane Neck Arm is not suitable.
	SA 140 G	Gold			
<b>CRANE TUBE ARM ONLY</b>					
	SP 140 TA	Chrome			140 mm Crane Tube Arm only for fitting to Twin Waters models when 330 mm arm is too high.
<b>SA 345 - SWIVEL SWAN NECK ARM</b>					
	SA 345 C	Chrome			330 mm ½" M & F brass swivel swan neck arm. The arm increases the height of the shower rose 250 mm above the wall outlet and projects the shower rose 345 mm from the wall. Most suitable for installations where shower height is required above wall outlet and drop down, fixed or adjustable arms are not desired. A ½" BSP spigot screws onto the wall outlet. The arm encapsulates the spigot and is fastened by grub screw for final connection. Supplied with 57 mm flat flange.
	SA 345 AC	Colour			
	SA 345 SC	Satin Completely			
	SA 345 G	Gold			
<b>SA 350 - 350 mm VERTICAL ARM</b>					
	SA 350 C	Chrome			350 mm ½" M & F brass vertical style fixed arm. Designed for ceiling overhead installations. A ½" BSP spigot screws onto the ceiling outlet. The arm encapsulates the spigot and is fastened by grub screw for final connection. Supplied with 57 mm flat flange.
	SA 350 G	Gold			
<b>SA 200 - 200 mm VERTICAL ARM</b>					
	SA 200 C	Chrome			200 mm ½" M & F brass vertical style fixed arm. Designed for ceiling overhead installations. A ½" BSP spigot screws onto the ceiling outlet. The arm encapsulates the spigot and is fastened by grub screw for final connection. Supplied with 57 mm flat flange.
	SA 200 G	Gold			
<b>SA 310 - 310 mm HORIZONTAL ARM</b>					
	SA 310 C	Chrome			310 mm ½" M & F brass fixed horizontal arm. A ½" BSP spigot screws onto the wall outlet. The arm encapsulates the spigot and is fastened by grub screw for final connection. Supplied with 57 mm flat flange.
	SA 310 G	Gold			
<b>FLANGE - DOMED &amp; SQUARE</b>					
	WF 057 D-C	Chrome			57 mm light weight stainless steel domed flange.
	WF 057 D-AC	Colour			
	WF 057 F-C	Chrome			57 mm heavy weight brass flat flange.
	WF 057 F-AC	Colour			
	WF 057 F-SC	Satin Completely			
	WF 057 F-G	Gold			
	WF 057 Q-C	Chrome			57 mm heavy weight brass square flange.
	WF 057 Q-AC	Colour			
	WF 057 Q-SC	Satin Completely			
	WF 057 Q-G	Gold			

	Code	Finish	Without GST	With GST	Features
<b>AF 5 FVB &amp; AF 8 FVB - AERATOR FLOW CONTROL INSERT - BUBBLE SPRAY</b>					
	AF 5 FVB	ABS - 5 L/min			Bubble spray aerator flow valve insert. Remove old aerator insert and replace. 5 Star - 6 L/min, 3 Star - 9 L/min rated as per WELS licence number 0046.  <b>BUBBLE SPRAY</b> 
	AF 8 FVB	ABS - 8 L/min			
<b>AF 22 DFB - DOMESTIC AERATOR FLOW CONTROL - BUBBLE SPRAY</b>					
	AF 22 DFB5-C	Chrome - 5 L/min			Domestic female threaded bubble spray flow control aerator for metric 24 male threaded spouts. Aerator insert is Watermark® and WELS approved, as per licence number 0046.
	AF 22 DFB8-C	Chrome - 8 L/min			
	AF 22 DFB5-G	Gold - 5 L/min			
	AF 22 DFB8-G	Gold - 8 L/min			
<b>AF 24 DMB - DOMESTIC AERATOR FLOW CONTROL - BUBBLE SPRAY</b>					
	AF 24 DMB5-C	Chrome - 5 L/min			Domestic male threaded bubble spray flow control aerator for metric 22 female threaded spouts. Aerator insert is Watermark® and WELS approved, as per licence number 0046.
	AF 24 DMB8-C	Chrome - 8 L/min			
	AF 24 DMB5-G	Gold - 5 L/min			
	AF 24 DMB8-G	Gold - 8 L/min			
<b>AF 22 VFB - ANTI VANDAL AERATOR FLOW CONTROL - BUBBLE SPRAY</b>					
	AF 22 VFB5-C	Chrome - 5 L/min			Anti-vandal female threaded bubble spray flow control aerator for metric 24 male threaded spouts. Aerator insert is Watermark® and WELS approved, as per licence number 0046. For installation where vandalism is a consideration. Anti-vandal fitting key supplied.
	AF 22 VFB8-C	Chrome - 8 L/min			
<b>AF 24 VMB - ANTI VANDAL AERATOR FLOW CONTROL - BUBBLE SPRAY</b>					
	AF 24 VMB5-C	Chrome - 5 L/min			Anti-vandal male threaded bubble spray flow control aerator for metric 22 female threaded spouts. Aerator insert is Watermark® and WELS approved, as per licence number 0046. For installation where vandalism is a consideration. Anti-vandal fitting key supplied.
	AF 24 VMB8-C	Chrome - 8 L/min			
<b>AF 5 TMB &amp; AF 8 TMB - AERATOR FLOW CONTROL INSERT - TINY MAN</b>					
	AF 5 TMB	ABS - 5 L/min			15 mm bubble spray flow control aerator insert. Remove old aerator insert and replace. 5 Star - 6 L/min, 3 Star - 9 L/min, as per WELS licence number 0046.  <b>BUBBLE SPRAY</b> 
	AF 8 TMB	ABS - 8 L/min			
<b>AF 15 DFB - DOMESTIC AERATOR FLOW CONTROL - MINI VALVE</b>					
	AF 15 DFB5-C	Chrome - 5 L/min			Domestic Tiny Man female threaded bubble spray flow control aerator for metric 16 mm male threaded spouts. Aerator insert is WELS approved as per licence number 0046.
	AF 15 DFB8-C	Chrome - 8 L/min			
	AF 15 DFB5-G	Gold - 5 L/min			
	AF 15 DFB8-G	Gold - 8 L/min			
<b>AF 15 DMB - DOMESTIC AERATOR FLOW CONTROL - MINI VALVE</b>					
	AF 15 DMB5-C	Chrome - 5 L/min			Domestic Tiny Man male threaded bubble spray flow control aerator for metric 18 mm female threaded spouts. Aerator insert is WELS approved as per licence number 0046.
	AF 15 DMB8-C	Chrome - 8 L/min			
	AF 15 DMB5-G	Gold - 5 L/min			
	AF 15 DMB8-G	Gold - 8 L/min			

	Code	Finish	Without GST	With GST	Features
<b>AF 2 FVS &amp; AF 5 FVS - AERATOR FLOW CONTROL INSERT - STREAM SPRAY</b>					
	AF 2 FVS	ABS - 2 L/min			Stream spray aerator flow valve insert. Remove old aerator insert and replace. 6 Star - 2 L/min, 5 Star - 6 L/min rated as per WELS licence number 0046.
	AF 5 FVS	ABS - 5 L/min			
					STREAM SPRAY 
<b>AF 22 DFS - DOMESTIC AERATOR FLOW CONTROL - STREAM SPRAY</b>					
	AF 22 DFS2-C	Chrome - 2 L/min			Domestic female threaded stream spray flow control aerator for metric 24 male threaded spouts. Aerator insert is WELS approved as per licence number 0046.
	AF 22 DFS5-C	Chrome - 5 L/min			
	AF 22 DFS2-G	Gold - 2 L/min			
	AF 22 DFS5-G	Gold - 5 L/min			
<b>AF 24 DMS - DOMESTIC AERATOR FLOW CONTROL - STREAM SPRAY</b>					
	AF 24 DMS2-C	Chrome - 2 L/min			Domestic male threaded stream spray flow control aerator for metric 22 female threaded spouts. Aerator insert is WELS approved as per licence number 0046.
	AF 24 DMS5-C	Chrome - 5 L/min			
	AF 24 DMS2-G	Gold - 2 L/min			
	AF 24 DMS5-G	Gold - 5 L/min			
<b>AF 22 VFS - ANTI VANDAL AERATOR FLOW CONTROL - STREAM SPRAY</b>					
	AF 22 VFS2-C	Chrome - 2 L/min			Anti-vandal female threaded stream spray flow control aerator for metric 24 male threaded spouts. Aerator insert is WELS approved as per licence number 0046. For installations where vandalism is a consideration. Anti-vandal fitting key supplied.
	AF 22 VFS5-C	Chrome - 5 L/min			
					
<b>AF 24 VMS - ANTI VANDAL AERATOR FLOW CONTROL - STREAM SPRAY</b>					
	AF 24 VMS2-C	Chrome - 2 L/min			Anti-vandal male threaded stream spray flow control aerator for metric 22 female threaded spouts. Aerator insert is WELS approved as per licence number 0046. For installations where vandalism is a consideration. Anti-vandal fitting key supplied.
	AF 24 VMS5-C	Chrome - 5 L/min			
					
<b>AF 20 - SINK SPRAY SWIVEL AERATOR - STREAM &amp; BUBBLE SPRAY</b>					
	AF 20-C	Chrome			Premium constructed female thread, sink spray aerator, with metric 22 threaded brass ball joint and robust Novodur P2MC natural ABS plastic housing, for use with cold water and hot water up to 85 °C. For fitting to male thread outlet spouts. Supplied with 8 L/min constant flow regulator water saving valve. Can be removed if not required. Adaptor supplied to suit male or female connection.
	AF 20-WT	White			
<b>AF 22 F - AERATOR FLOW CONTROL ADAPTOR</b>					
	AF 22 F-C	Chrome			DR brass female threaded aerator flow control adaptor for metric 22 female threaded aerators. Fit to male threaded outlet spouts. Remove existing spout aerator, thread on flow control adaptor and refit spout aerator. 6 Star - not more than 4.5 L/min, 5 Star - 6 L/min, 3 Star - 9 L/min, 2 Star - 12 L/min rated as per WELS licence number 0046.
	AF 22 F-G	Gold			
		Available flow rates 2, 4, 6, 9, 12 L/m			
<b>AF 24 M - AERATOR FLOW CONTROL ADAPTOR</b>					
	AF 24 M-C	Chrome			DR brass male threaded aerator flow control adaptor for metric 24 male threaded aerators. Fit to female threaded outlet spouts. Remove existing spout aerator, thread on flow control adaptor and refit spout aerator. 6 Star - not more than 4.5 L/min, 5 Star - 6 L/min, 3 Star - 9 L/min, 2 Star - 12 L/min rated as per WELS licence number 0046.
	AF 24 M-G	Gold			
		Available flow rates 2, 4, 6, 9, 12 L/m			











All purpose flow regulated valves to suit every flow control situation.

	Code	Finish	Without GST	With GST	Features
<b>AF 019 - FLOW CONTROL DISC</b>					
	AF 019 - 6 L/min	Brass			DR brass 19 mm Flow control disc. Fit with hat up facing direction of water flow. Flow rates available 6, 9, 12 L/min.
	AF 019 - 9 L/min	Brass			
	AF 019 - 12 L/min	Brass			
<b>AF 086 - 1/2" FLOW INTERCHANGE SPIGOT</b>					
	AF 086	Brass			1/2" DR brass female inlet Flow Interchange Spigot valve for connection to Con-Serv exclusive spigot body inlets. Flow rates available 6, 9, 12 and 15 L/min.
<b>AF 053 - BASIN FLOW CONTROL VALVE</b>					
	AF 053 C	Chrome			1/2" M&F DR brass 35 mm long constant flow regulator valve. 1/2" BSP male inlet, 1/2" BSP female outlet. Designed to accept hose tails or compression nut and olive. 6 Star - not more than 4.5 L/min, 5 Star - 6 L/min, 3 Star - 9 L/min, 2 Star - 12 L/min rated as per WELS licence number 0046.
<b>AF 054 - FLOW CONTROL VALVE</b>					
	AF 054 C	Chrome			1/2" F&M DR brass 35 mm long constant flow regulator valve. 1/2" BSP female inlet, 1/2" BSP male outlet. Designed to accept hose tails or compression nut and olive. 6 Star - not more than 4.5 L/min, 5 Star - 6 L/min, 3 Star - 9 L/min, 2 Star - 12 L/min rated as per WELS licence number 0046. To reduce filling noise of toilets, use a 5 L/min model.
	AF 054 AC	Colour			
	AF 054 SC	Satin Completely			
	AF 054 PB	Polish Brass			
	AF 054 G	Gold			
<b>AF 055 - FLANGE FLOW CONTROL VALVE</b>					
	AF 055 C	Chrome			1/2" F&M DR brass sculptured flange, 30 mm long x 55 mm diameter constant flow regulator. 1/2" BSP female inlet and 1/2" BSP male outlet. 6 Star - not more than 4.5 L/min, 5 Star - 6 L/min, 3 Star - 9 L/min, 2 Star - 12 L/min rated as per WELS licence number 0046.
	AF 055 AC	Colour			
	AF 055 SC	Satin Completely			
	AF 055 PB	Polished Brass			
	AF 055 G	Gold			
<b>AF 048 - WHISPER WASH® - MK 1</b>					
	AF 048 C	Chrome			3/4" F&M DR brass (20 mm), 38 mm long flow regulator non-return valve for appliance noise reduction. Suitable for washing machines, dishwashers and all water-using appliances with 3/4" BSP hose connections. Equipped with stainless steel filter screen. Seal to inlet and flat seal to outlet. Flow rate 9 L/min.
<b>AF 059 - 3/4" M&amp;F HOSE TAP FLOW REGULATOR</b>					
	AF 059 C	Chrome			3/4" M&F DR brass (20 mm) hose cock flow regulator. Also suitable for use with water using appliances having 3/4" BSP hose connections. Ideal for top loading washing machines to limit flow when flood stop valves are installed. Connect valve to inlet thread of machine. Flow rates 9 and 12 L/min.









## FLOOD STOP VALVE

<b>FS 038 - FLOOD STOP VALVE</b>					
	FS 038 C	Chrome			3/4" F&M DR brass flood stop valve prevents the uncontrolled water flow from burst pressure hoses used for water supply to domestic dish washing machines and front load washing machines. The safety valve will close and shut off the water when the flow is greater than 17 L/min. In the case of leaking hoses or a flow rate below 17 L/min, the flood stop will not close. Minimum operating pressure 200 kPa static.

ISOLATING BALL VALVES		Code	Finish	Without GST	With GST	Features
<b>BV 100 - WHISPER FLOW® ½" x ½" ISOLATING BALL VALVE</b>						
	BV 100	Chrome				<p>½" F&amp;M, filtered single line water supply flow controller and isolating valve. Male outlet compatible with compression nut and olive. 6 Star - not more than 4.5 L/min, 5 Star - 6 L/min, 3 Star - 9 L/min, 2 Star - 12 L/min rated as per WELS licence number 0046. To reduce filling noise of toilets, use a 5 L/min model.</p> <p><b>NOTE:</b> Some instantaneous heaters will not work with flow rates below 9 L/min. Check prior to installation.</p> 
<b>BV 105 - WHISPER CHECK® ½" x ½" ISOLATING BALL VALVE</b>						
	BV 105	Chrome				<p>½" F&amp;M, filtered Dual check backflow prevention isolating valve for low hazard conditions. Male outlet compatible with compression nut and olive. 6 Star - not more than 4.5 L/min, 5 Star - 6 L/min, 3 Star - 9 L/min, 2 Star - 12 L/min rated as per WELS licence number 0046.</p> <p><b>NOTE:</b> Some instantaneous heaters will not work with flow rates below 9 L/min. Check prior to installation.</p> 
<b>BV 110 - WHISPER WASH® MK2 ½" x ¾" ISOLATING BALL VALVE</b>						
	BV 110	Chrome				<p>Noise reduction filtered isolating valve for washing machines and dish washers. ½" BSP female inlet to ¾" BSP male outlet. Available flow rates 6, 9 and 12 L/min.</p> <p><b>NOTE:</b> Some instantaneous heaters will not work with flow rates below 9 L/min. Check prior to installation.</p> 
<b>BV 115 - WHISPER STOP ½" x ¾" ISOLATING BALL VALVE</b>						
	BV 115	Chrome				<p>Noise reduction filtered isolating valve for outside exterior tapware and areas requiring dual check backflow prevention isolating valve. ½" BSP female inlet to ¾" BSP male outlet. Supplied full flow. 6, 9 and 12 L/min available on request.</p> 

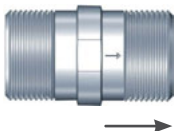
## DUAL CHECK/NON-RETURN VALVES

<b>DC 042 - DUAL CHECK/NON-RETURN ½" M&amp;F</b>						
	DC 042 C	Chrome				<p>FOR PILLAR COCKS AND LABORATORY FITTINGS. ½" M&amp;F DR 60 mm long valve for dual check/non-return protection. ½" BSP male threaded inlet and ½" BSP female outlet. Male end designed to accept compression nut and olive. Flow rates 6, 9 and 12 L/min.</p> <p><b>NOTE:</b> Unless specified this valve will be supplied full flow.</p> 
<b>DC 043 - DUAL CHECK/NON-RETURN ½" F&amp;M</b>						
	DC 043 C	Chrome				<p>FOR IN-LINE, HOB MOUNT SETS AND END OF LINE FITTINGS. ½" F&amp;M DR 60 mm long valve for dual check/non-return protection. ½" BSP female threaded inlet and ½" BSP male outlet. Male end designed to accept compression nut and olive. Flow rates 6, 9 and 12 L/min.</p> <p><b>NOTE:</b> Unless specified this valve will be supplied full flow.</p> 
<b>DC 057 - DUAL CHECK/NON-RETURN ½" M&amp;M</b>						
	DC 057 C	Chrome				<p>½" M&amp;M DR brass 39 mm long valve for in-line dual check/non-return protection. ½" BSP male threaded inlet and outlet. Flow rates 6, 9 and 12 L/min.</p> <p><b>NOTE:</b> Unless specified this valve will be supplied full flow.</p> 



METER-BEATER® is a complete system that provides a new seat and seal mechanism with integral flow control for screw down taps and is flow controlled to regulate any tap to a maximum flow rate to eliminate excess water use.

Recommended flow rates are 4 or 6 litres at basins, 9 litres at kitchen outlets and 12 litres for baths and laundry tubs.

	Code		Without GST	With GST	Features
<b>MB 045 - METER-BEATER® ½" SCREW DOWN TAPWARE</b>					
	MB 045	Single unit			FLOW CONTROL FOR SCREW DOWN TAPWARE Flow controlled DR brass and sealed system for tapware. Seat equipped with 9/16" brass thread with 8 mm hexagonal core and nitrile rubber seal. The Meter-Beater® saves hot and cold water, reduces plumbing noise and stops line-robbing that can cause shower temperature fluctuations. 6 Star - not more than 4.5 L/min, 5 Star - 6 L/min, 2 Star - 12 L/min rated as per WELS licence number 0046.
<b>MB 045 OR - METER-BEATER® VALVE BODY "O" RING SEAL</b>					
	MB 045 OR-01	Single			 <p>WaterMark AS 5200.037.2 WMKA 00667</p>
	MB 045 OR-10	10 Pack			
	MB 045 OR-20	20 Pack			
	Meter-Beater® valve body nitrile 70 'O' ring seal.				
<b>MB 047 - METER-BEATER® ½" CERAMIC DISC TAPWARE</b>					
	MB 047	Single unit			CERAMIC DISC TAP FLOW CONTROL Flow control seat insert with 9/16" brass thread with 8 mm hexagonal core. Suits quarter ¼", ½" and ¾" turn ceramic disc tapware. 6 Star - not more than 4.5 L/min, 5 Star - 6 L/min, 2 Star - 12 L/min rated as per WELS licence number 0046.
<b>MB 043 IK - METER-BEATER® INSTALLATION KIT</b>					
	MB 043 IK				<ul style="list-style-type: none"> <li>• 9/16" Tapping tool</li> <li>• Tapping tool guide</li> <li>• 8 mm Allen key</li> <li>• Spindle flush plug</li> </ul>
<b>MB 043 TT - METER-BEATER® TAPPING TOOL</b>					
	MB 043 TT				9/16" tapping tool for threading of tap body to take Meter-Beater® valve housing.
<b>MB 043 RT - METER-BEATER® REAMER TOOL</b>					
	MB 043 RT	Reamer Tool			Reamer tool with safety stop lip for increasing undersized tap seat bore size to 12.5 mm to accept 9/16" Tapping tool for threading in preparation for installing the Meter-Beater® or stainless steel tap seats.
<b>MB 043 FP - SPINDLE FLUSH PLUG</b>					
	MB 043 FP				Spindle flush plug for installation of Meter-Beater®.
<b>MB 045 JV - METER-BEATER® JUMPER VALVE</b>					
	MB 045 JV-01	Single			Acetal jumper valve with nitrile 'O' ring seat to suit ½" tap. Suits Meter-Beater® model MB 045.
	MB 045 JV-05	5 Pack			
	MB 045 JV-10	10 Pack			

	Code	Finish	Without GST	With GST	Features
<b>DV 044 - ON/OFF BUTTON CONTROL VALVE</b>					
	DV 044	Chrome			On/off shower valve. Brass made.
					<b>NOT TO BE USED AS A LINE END STOP CONTROL.</b>
<b>AF 071 - TOILET CISTERN WATER FLUSH REGULATOR</b>					
	AF 071	Blue			Hang or clip to toilet cistern Flush Outlet Valve operating mechanism. Toilet Cistern Water Flush Regulator contains 3 separate brass weights to regulate water volume and flushing time. Maintain all weights in Toilet Cistern Water Flush Regulator tube for maximum water saving or adjust number of weights to suit flushing requirements. Reduce water usage by up to 70%. Fits all cisterns with open overflow outlet.
<b>FM 070 - BASIN FLOW MEASURING CUP</b>					
	FM 070	Blue			Flow test cup for measuring flow rate of water from tapware. Test range 3 to 20 L/min.
<b>FM 075 - SHOWER FLOW MEASURING JUG</b>					
	FM 075	Blue			Flow test jug for measuring flow rate of water from showers. Test range 4.5 to 24 L/min.
<b>SD 025 - ABS 25 mm SOAP DISH</b>					
	SD 025 CL	Clear			Rail soap dish. Oval star pattern. Size - 115 mm x 175 mm. Clear ABS for 25 mm rail.
<b>HC 025 - ABS SLIDE RAIL HANDPIECE CRADLE</b>					
	HC 025 C	Chrome			ABS slide rail cradle. Supports handpiece/hose on 25 mm tube Slide Rail. Button lock mechanism.
	HC 025 WT	White			
	HC 025 IV	Ivory			
<b>HC 020 - BRASS SLIDE RAIL HANDPIECE CRADLE</b>					
	HC 020 C	Chrome			Brass Slide Rail Cradle for a 25 mm tube rail. "C"hook supports handpiece with hose.
	HC 020 WTC	White/Chrome			
	HC 020 WTG	White/Gold			
	HC 020 IV	Ivory/Chrome			
	HC 020 IVG	Ivory/Gold			
<b>HC 010 - BRASS FRICTION SLIDE HANDPIECE CRADLE</b>					
	HC 010 C	Chrome			Brass Friction Slide Cradle for Con-Serv® Crystal Slide Track Rail only.
	HC 010 ACC	Colour/Chrome			
	HC 010 ACG	Colour/Gold			
	HC 010 SC	Satin Chrome			
	HC 010 G	Gold			



# Shower Systems for Healthcare Applications

Shower systems for healthcare applications usually require the installation of height adjustable handheld showers to cater for the able bodied as well as those who need to use a shower chair to clean themselves. There must also be provisions for assistance where someone is incapable of performing the cleaning task unaided. Handheld showers for these applications should be light weight, capable of withstanding dropping, easily held in soapy hands and have a soft spray pattern as to not irritate sensitive skin. Hoses should have a smooth surface to allow thorough cleaning as well. Con-Serv's HOSFAB® handheld showers and hoses meet these requirements.

Where requested a handpiece that has an additional pulsating action to relax or to provide aqua-massage hydrotherapy treatment to relieve pain or promote healing can be supplied.

Handheld showers for professional use are supplied with licenced dual check valves to stop contamination of the water system. As with all Con-Serv handheld showers, the valves are located with the flow control at the wall outlet elbow.

Careful selection from the HOSFAB® range will result in a shower support system that has been designed to fit many applications and give years of reliable service.



## Select from our four ranges of HOSFAB® shower systems for healthcare applications

PWD HOSFAB® .....	48 - 49
Commercial HOSFAB® .....	50 - 53
Standard HOSFAB® .....	54 - 57
Premium HOSFAB® .....	58 - 61





# REFERENCE GUIDE TO COMMERCIAL HS 018 & PWD HOSFAB® KITS

For pricing refer to pages 49–53



## HS 018 HOSFAB® KITS

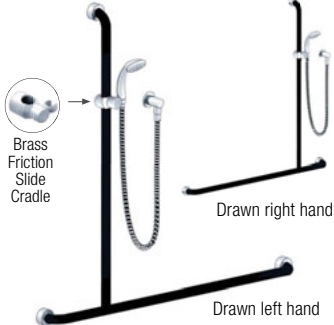

 <p>Features and benefits page 51</p> <p>HS 018 KIT 1</p>	 <p>Brass Friction Slide Cradle</p> <p>Features and benefits page 51</p> <p>HS 018 KIT 3</p>	 <p>Brass Friction Slide Cradle</p> <p>Drawn right hand</p> <p>Drawn left hand</p> <p>Features and benefits page 51</p> <p>HS 018 KIT 5</p>	 <p>ABS Glide Slide Cradle</p> <p>Features and benefits page 51</p> <p>HS 018 KIT 6</p>
 <p>Features and benefits page 51</p> <p>HS 018 KIT 7</p>	 <p>ABS Glide Slide Cradle</p> <p>Features and benefits page 52</p> <p>HS 018 KIT 9</p>	 <p>Features and benefits page 52</p> <p>HS 018 KIT 12</p>	 <p>ABS Glide Slide Cradle</p> <p>Drawn right hand</p> <p>Drawn left hand</p> <p>Features and benefits page 52</p> <p>HS 018 KIT 13</p>
 <p>ABS Glide Slide Cradle</p> <p>Drawn right hand</p> <p>Drawn left hand</p> <p>Features and benefits page 52</p> <p>HS 018 KIT 14</p>	 <p>ABS Glide Slide Cradle</p> <p>Drawn right hand</p> <p>Drawn centre fix</p> <p>Drawn left hand</p> <p>Features and benefits page 53</p> <p>HS 018 KIT 16</p>	 <p>Brass Friction Slide Cradle</p> <p>Drawn right hand</p> <p>Drawn centre fix</p> <p>Drawn left hand</p> <p>Features and benefits page 53</p> <p>HS 018 KIT 20</p>	 <p>Brass Friction Slide Cradle</p> <p>Drawn right hand</p> <p>Drawn left hand</p> <p>Features and benefits page 53</p> <p>HS 018 KIT 21</p>

## PWD HOSFAB® KITS

 <p>Features and benefits page 53</p> <p>HS 018 KIT 22</p>	 <p>Brass Friction Slide Cradle with PUSH-PULLME®</p> <p>Features and benefits page 49</p> <p>ID 018-3</p>	 <p>Brass Friction Slide Cradle with PUSH-PULLME®</p> <p>Drawn right hand</p> <p>Drawn left hand</p> <p>Features and benefits page 49</p> <p>ID 018-20</p>	 <p>Brass Friction Slide Cradle with PUSH-PULLME®</p> <p>Drawn right hand</p> <p>Drawn left hand</p> <p>Features and benefits page 49</p> <p>ID 018-21</p>
---	---	--	---



# PWD HOSFAB® - INDEPENDENT ACCESSIBLE HEALTHCARE SHOWER KIT FOR SEATED USERS

1000 mm Satin Supreme 304 independent accessible grab rail/shower kit, assembled with 50 mm  HYGIENIC SEAL® healthsafe flange covers and **Brass Friction Slide Cradle** with "PUSH-PULLME®" handset height adjustment rod for seated users. The  HYGIENIC SEAL® healthsafe flange with Thermoplastic Elastomer (TPE) fitted seal prevents grime such as soap scum, body fluids, ointments and aqueous based fluids accumulating behind the flange cover and creating possible serious health issues. Putting health and hygiene foremost, the grab rails comply with clause 17 of AS 1428.1-2009 for

Design and Construction.



MODEL SHOWN ID 018-3 INDEPENDENT ACCESSIBLE HOSFAB®

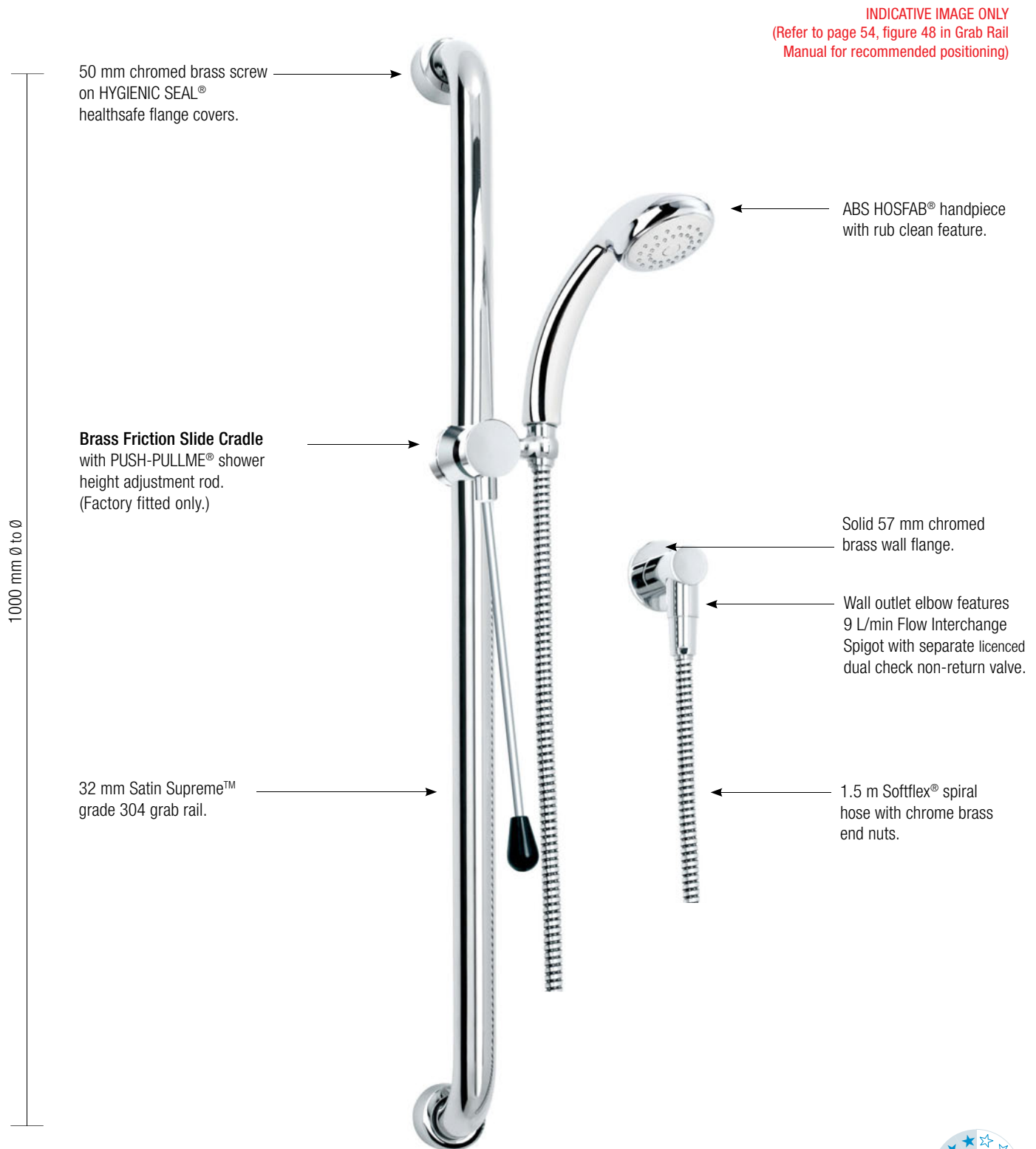

INDICATIVE IMAGE ONLY  
(Refer to page 54, figure 48 in Grab Rail Manual for recommended positioning)

50 mm chromed brass screw on HYGIENIC SEAL® healthsafe flange covers.

ABS HOSFAB® handpiece with rub clean feature.

Brass Friction Slide Cradle with PUSH-PULLME® shower height adjustment rod. (Factory fitted only.)

Solid 57 mm chromed brass wall flange.

Wall outlet elbow features 9 L/min Flow Interchange Spigot with separate licenced dual check non-return valve.

32 mm Satin Supreme™ grade 304 grab rail.

1.5 m Sofftflex® spiral hose with chrome brass end nuts.

Stainless steel screws and wall plugs provided.



Hygienic seal

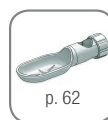

p. 62

Optional extra: SD 032 Soap Dish



WaterMark  
AS/NZS 3662  
WMKT 21147



Lic. no. 0046





# PWD HOSFAB® - HEALTHCARE KIT WITH PUSH-PULLME® FOR SEATED USERS

Independent accessible healthcare kits are made from the highest quality tested products and materials and feature dual check facilities as per AS/NZ 3500. The grab rails are fabricated from 304 stainless steel and assembled with 50 mm chromed brass screw on HYGIENIC SEAL® flange covers with Thermoplastic Elastomer (TPE) fitted seals and comply with clause 17 of AS 1428.1-2009 for Design and Construction.



## AS 1428.1 - 2009 15.5.6 Shower Head

An adjustable shower head holder shall be provided to support the shower head and shall allow the graspable portion of the shower head to be positioned at various angles and heights and also allow the graspable portion of the shower head to be located at heights between 1000 mm and 1800 mm above the plane of the finished floor and allow access and adjustment from a seated position.

*The above clause only applies to bathrooms specifically designed for People with Disabilities (PWD) in public buildings, factories, hotels, motels and designated PWD bathrooms in hospitals, homes for the elderly and nursing homes.*

	Code	Finish	GST Free	Features
--	------	--------	----------	----------

### ID 018-3 INDEPENDENT HOSFAB® - PWD

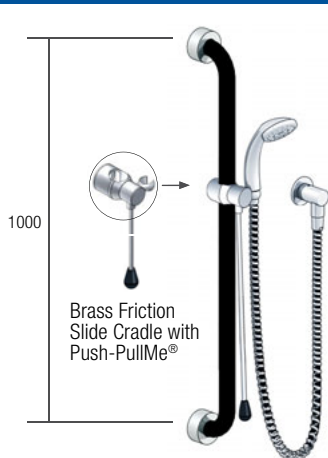

ID 018-03 CW	Chrome/White	1.5 m hose	
ID 018-03 C	Chrome	1.5 m hose	
ID 018-03 CW2	Chrome/White	2 m hose	
ID 018-03 C2	Chrome	2 m hose	

1000 mm Satin Supreme™ grab rail, assembled with HYGIENIC SEAL® healthsafe flange covers and **Brass Friction Slide Cradle** with PUSH-PULLME® shower height adjustment rod for seated persons. Also includes a strong and stylish ABS handpiece, PVC reinforced Soffflex® spiral hose and wall outlet elbow which features 9 L/min Flow Interchange Spigot and separate licenced dual check/non return valves to prevent back siphonage.

3 Star - 9 L/min rated as per WELS licence number 0046. Complies with requirements for a 2 walled shower enclosure when installed with HS 700 as per 1428.1-2009.



INDICATIVE IMAGE ONLY  
(Refer to page 54, figure 48 in Grab Rail Manual for recommended positioning)

### ID 018-20 INDEPENDENT HOSFAB® - PWD Please specify left or right hand



ID 018-20 CW	Chrome/White	1.5 m hose	
ID 018-20 C	Chrome	1.5 m hose	
ID 018-20 CW2	Chrome/White	2 m hose	
ID 018-20 C2	Chrome	2 m hose	

#### TO SUIT ACCESSIBLE SHOWER RECESS.

700 mm x 1100 mm Satin Supreme™ inverted "T" handed grab rail, assembled with HYGIENIC SEAL® healthsafe flange covers and **Brass Friction Slide Cradle** with PUSH-PULLME shower height adjustment rod for seated persons. Also includes a strong and stylish ABS handpiece, PVC reinforced Soffflex® spiral hose and wall outlet elbow which features 9 L/min Flow Interchange Spigot and separate licenced dual check/non return valves to prevent back siphonage.

3 Star - 9 L/min rated as per WELS licence number 0046. Complies with requirements for a 2 walled shower enclosure as per 1428.1-2009.



INDICATIVE IMAGE ONLY  
(Refer to page 54, figure 48 in Grab Rail Manual for recommended positioning)

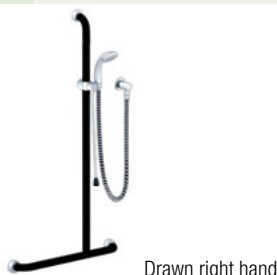

### ID 018-21 INDEPENDENT HOSFAB® - PWD Please specify left or right hand

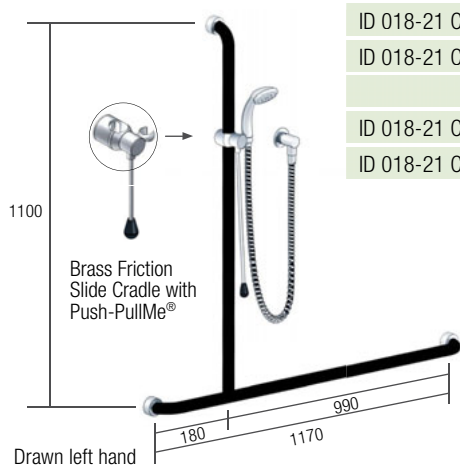

ID 018-21 CW	Chrome/White	1.5 m hose	
ID 018-21 C	Chrome	1.5 m hose	
ID 018-21 CW2	Chrome/White	2 m hose	
ID 018-21 C2	Chrome	2 m hose	

#### TO SUIT COMBINED ACCESSIBLE SANITARY COMPARTMENT.

1170 mm x 1100 mm Satin Supreme™ inverted "T" handed grab rail, assembled with HYGIENIC SEAL® healthsafe flange covers and **Brass Friction Slide Cradle** with PUSH-PULLME shower height adjustment rod for seated persons. Also includes a strong and stylish ABS handpiece, PVC reinforced Soffflex® spiral hose and wall outlet elbow which features 9 L/min Flow Interchange Spigot and separate licenced dual check/non return valves to prevent back siphonage.



3 Star - 9 L/min rated as per WELS licence number 0046. Complies with requirements for a 2 walled shower enclosure as per 1428.1-2009.



INDICATIVE IMAGE ONLY  
(Refer to page 56, figure 50 in Grab Rail Manual for recommended positioning)



# COMMERCIAL HOSFAB® - HEALTHCARE SHOWER KIT WITH BRASS FRICTION SLIDE CRADLE AND ABS SLIDE CRADLE OPTIONS

900 mm Satin Supreme 304 grab rail/shower kit, assembled with 50 mm  HYGIENIC SEAL® healthsafe flange covers and **BRASS FRICTION SLIDE CRADLE** (ABS OPTIONAL). The  HYGIENIC SEAL® healthsafe flange with Thermoplastic Elastomer (TPE) fitted seal prevents grime such as soap scum, body fluids, ointments and aqueous based fluids accumulating behind the flange cover and creating possible serious health issues. Putting health and hygiene foremost, the grab rails comply with clause 17 of AS 1428.1-2009 for Design and Construction. 

MODEL SHOWN HS 018-3 COMMERCIAL HOSFAB® KIT

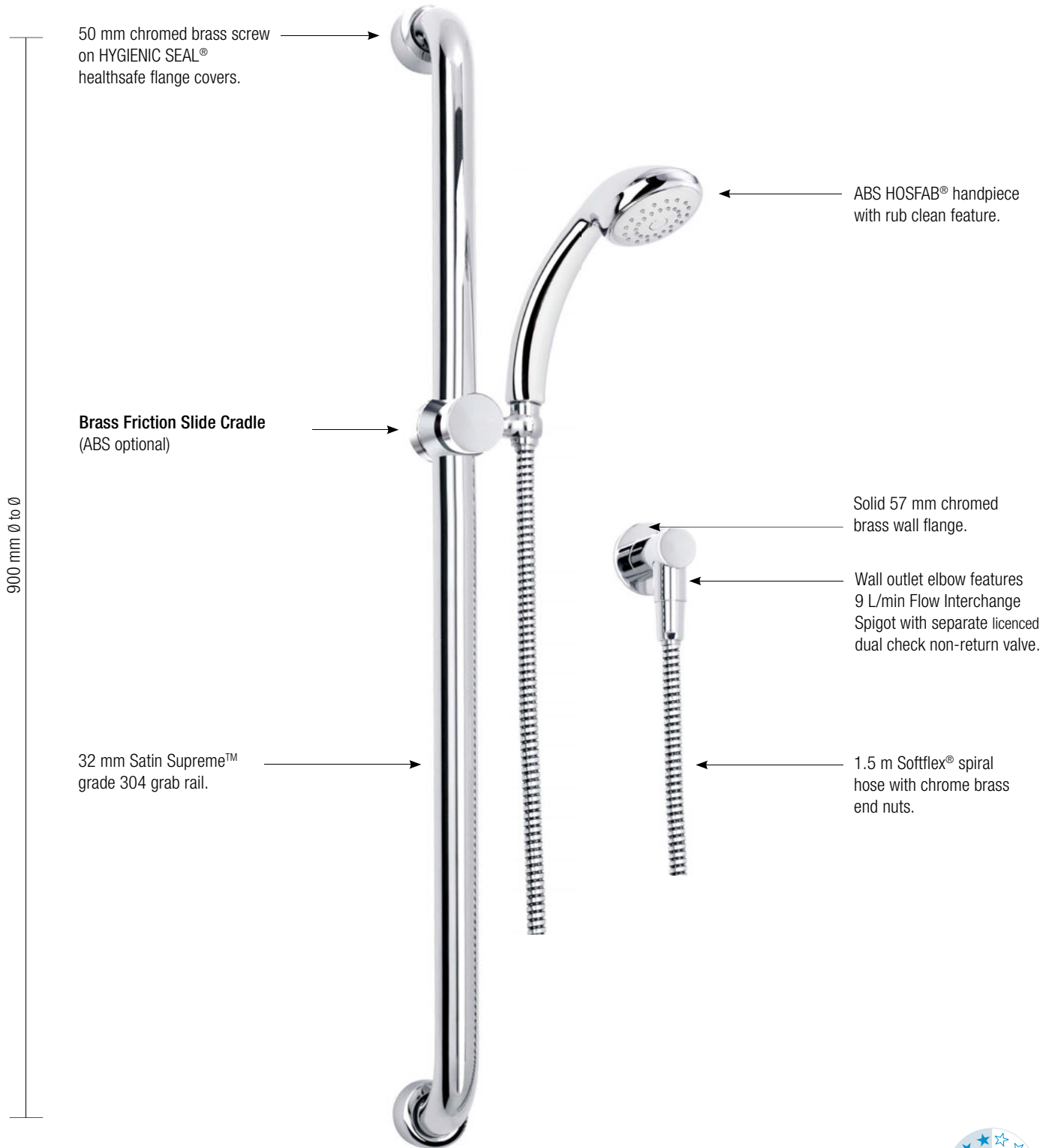

900 mm  $\varnothing$  to  $\varnothing$

50 mm chromed brass screw on HYGIENIC SEAL® healthsafe flange covers.

Brass Friction Slide Cradle (ABS optional)

32 mm Satin Supreme™ grade 304 grab rail.

ABS HOSFAB® handpiece with rub clean feature.

Solid 57 mm chromed brass wall flange.

Wall outlet elbow features 9 L/min Flow Interchange Spigot with separate licenced dual check non-return valve.

1.5 m Softflex® spiral hose with chrome brass end nuts.

Stainless steel screws and wall plugs provided.



Hygienic seal

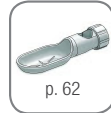

Optional extra: SD 032 Soap Dish









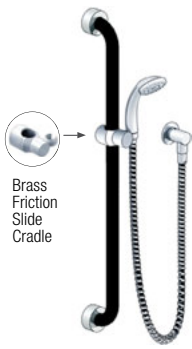

# COMMERCIAL HOSFAB® - OPTIONS

Commercial healthcare shower support options, made from the highest quality tested products and materials and feature dual check facilities as per AS/NZ 3500. Designed for installations in hospitals, homes for the elderly, nursing homes, private and public facilities. Grab rail kits comply with clause 17 of 1428.1-2009 for Design and Construction.











	Code	Finish	Without GST	With GST	GST Free	Features
<b>HS 018 KIT 1</b>						
	HS 018-01 CW	Chrome/White 1.5 m hose and handpiece				Handheld shower kit with stylish ABS handpiece, PVC 1.5 m reinforced Softflex® spiral hose and wall outlet elbow bracket which features 9 L/min Flow Interchange Spigot and separate licenced dual check/non-return valve to prevent back siphonage.  3 Star - 9 L/min rated as per WELS licence number 0046.
	HS 018-01 C	Chrome 1.5 m hose and handpiece				
<b>HS 018 KIT 3</b>						
 <p>Brass Friction Slide Cradle</p>	HS 018-03 CW	Chrome/White 1.5 m hose and handpiece				900 mm Satin Supreme™ grade 304 grab rail, assembled with HYGIENIC SEAL® healthsafe flange covers with <b>Brass Friction Slide Cradle</b> fastened and tensioned to the grab rail for handset support and movement. Also includes a strong and stylish ABS handpiece, PVC 1.5 m reinforced Softflex® spiral hose and wall outlet elbow which features 9 L/min Flow Interchange Spigot and separate licenced dual check/non return valves to prevent back siphonage.  3 Star - 9 L/min rated as per WELS licence number 0046.  Complies with requirements for 2 walled shower enclosure when installed with HS 700 as per AS 1428 - 2009.
	HS 018-03 C	Chrome 1.5 m hose and handpiece				
	HS 018-03 CW2	Chrome/White 2 m hose and handpiece				
	HS 018-03 C2	Chrome 2 m hose and handpiece				
						 
<b>HS 018 KIT 5</b> Please specify left or right hand						
 <p>Drawn right hand</p> <p>Drawn left hand</p> <p>Brass Friction Slide Cradle</p>	HS 018-05 CW	Chrome/White 1.5 m hose and handpiece				760 mm x 1000 mm x 1100 mm Satin Supreme™ grade 304 grab rail, assembled with HYGIENIC SEAL® healthsafe flange covers with <b>Brass Friction Slide Cradle</b> fastened and tensioned to the grab rail for handset support and movement. Also includes a strong and stylish ABS handpiece, PVC 1.5 m reinforced Softflex® spiral hose and wall outlet elbow which features 9 L/min Flow Interchange Spigot and separate licenced dual check/non return valves to prevent back siphonage.  3 Star - 9 L/min rated as per WELS licence number 0046.
	HS 018-05 C	Chrome 1.5 m hose and handpiece				
	HS 018-05 CW2	Chrome/White 2 m hose and handpiece				
	HS 018-05 C2	Chrome 2 m hose and handpiece				
						
<b>HS 018 KIT 6</b>						
 <p>ABS Glide Slide Cradle</p>	HS 018-06 CW	Chrome/White 1.5 m hose and handpiece				Handheld shower kit to suit 32 mm grab rail refurbishment. Kit includes <b>ABS Glide Slide Cradle</b> to be fastened and tensioned to the grab rail for handset support and movement. Also includes a stylish ABS handpiece, PVC 1.5 m reinforced Softflex® spiral hose and wall outlet elbow which features 9 L/min Flow Interchange Spigot and separate licenced dual check/non-return to prevent back siphonage.  3 Star - 9 L/min rated as per WELS licence number 0046.  NO GRAB RAIL SUPPLIED
	HS 018-06 C	Chrome 1.5 m hose and handpiece				
	HS 018-06 CW2	Chrome/White 2 m hose and handpiece				
	HS 018-06 C2	Chrome 2 m hose and handpiece				
<b>HS 018 KIT 7</b>						
	HS 018-07 CW	Chrome/White 1.5 m hose and handpiece				Psychiatric care handshower kit to suit 32 mm grab rail refurbishment with <b>quick release coupling</b> and dry break stop valve. Kit also includes the HOSFAB® handpiece, PVC high pressure reinforced Softflex® spiral hose and wall outlet elbow which features 9L/min Flow Interchange Spigot and separate licenced dual check/non return to prevent back siphonage.  3 Star - 9 L/min rated as per WELS licence number 0046.  NO GRAB RAIL SUPPLIED
	HS 018-07 C	Chrome 1.5 m hose and handpiece				
	HS 018-07 CW2	Chrome/White 2 m hose and handpiece				
	HS 018-07 C2	Chrome 2 m hose and handpiece				

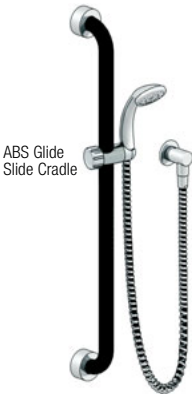

# COMMERCIAL HOSFAB® - OPTIONS

Commercial healthcare shower support options, made from the highest quality tested products and materials and feature dual check facilities as per AS/NZ 3500. Designed for installations in hospitals, homes for the elderly, nursing homes, private and public facilities. Grab rail kits comply with clause 17 of 1428.1-2009 for Design and Construction.



	Code	Finish	Without GST	With GST	GST Free	Features
<b>HS 018 KIT 9</b>						
	HS 018-09 CW	Chrome/White 1.5 m hose and handpiece				900 mm Satin Supreme™ grade 304 grab rail, assembled HYGIENIC SEAL® healthsafe flange covers with <b>ABS Glide Slide Cradle</b> fastened and tensioned to the grab rail for handset support and movement. Also includes a strong and stylish ABS handpiece, PVC reinforced Soffflex® spiral hose and wall outlet elbow which features 9 L/min Flow Interchange spigot and separate licenced dual check/non return valves to prevent back siphonage.  3 Star - 9 L/min rated as per WELS licence number 0046.  Complies with requirements for a 2 walled shower enclosure when installed with HS 700 SS as per AS 1428.1 -2009.
	HS 018-09 C	Chrome 1.5 m hose and handpiece				
	HS 018-09 CW2	Chrome/White 2 m hose and handpiece				
	HS 018-09 C2	Chrome 2 m hose and handpiece				
 						
<b>HS 018 KIT 12</b>						
	HS 018-12 CW	Chrome/White 1.5 m hose and handpiece				Handheld shower kit to suit 32 mm grab rail refurbishment. Also includes a stylish ABS handpiece, PVC 1.5 m reinforced Soffflex® spiral hose and wall outlet elbow which features 9 L/min Flow Interchange Spigot and separate licenced dual check/non-return valve to prevent back siphonage.  3 Star - 9 L/min rated as per WELS licence number 0046.  <b>HANDHELD SHOWER KIT FOR ALL GRAB RAIL MODELS.</b>
	HS 018-12 C	Chrome 1.5 m hose and handpiece				
	HS 018-12 CW2	Chrome/White 2 m hose and handpiece				
	HS 018-12 C2	Chrome 2 m hose and handpiece				
<b>HS 018 KIT 13</b>						
<b>Please specify left or right hand</b>						
	HS 018-13 CW	Chrome/White 1.5 m hose and handpiece				760 mm x 1000 mm x 1100 mm Satin Supreme™ grade 304 grab rail assembled with HYGIENIC SEAL® healthsafe flange covers with <b>ABS Glide Slide Cradle</b> fastened and tensioned to the grab rail for handset support and movement. Also includes a strong and stylish ABS handpiece, PVC reinforced Soffflex® spiral hose and wall outlet elbow which features 9 L/min Flow Interchange Spigot and separate licenced dual check/non return valves to prevent back siphonage.  3 Star - 9 L/min rated as per WELS licence number 0046.
	HS 018-13 C	Chrome 1.5 m hose and handpiece				
	HS 018-13 CW2	Chrome/White 2 m hose and handpiece				
	HS 018-13 C2	Chrome 2 m hose and handpiece				
						
<b>HS 018 KIT 14</b>						
<b>Please specify left or right hand</b>						
	HS 018-14 CW	Chrome/White 1.5 m hose and handpiece				400 mm x 1100 mm Satin Supreme™ grade 304 "L" shape grab rail assembled with HYGIENIC SEAL® healthsafe flange covers with <b>ABS Glide Slide Cradle</b> fastened and tensioned to the grab rail for handset support and movement. Also includes a strong and stylish ABS handpiece, PVC reinforced Soffflex® spiral hose and wall outlet elbow which features 9 L/min Flow Interchange Spigot and separate licenced dual check/non return valves to prevent back siphonage.  3 Star - 9 L/min rated as per WELS licence number 0046.  <b>MADE TO ORDER - NON RETURNABLE</b>
	HS 018-14 C	Chrome 1.5 m hose and handpiece				
	HS 018-14 CW2	Chrome/White 2 m hose and handpiece				
	HS 018-14 C2	Chrome 2 m hose and handpiece				
						





# COMMERCIAL HOSFAB® - OPTIONS

Commercial healthcare shower support options, made from the highest quality tested products and materials and feature dual check facilities as per AS/NZ 3500. Designed for installations in hospitals, homes for the elderly, nursing homes, private and public facilities. Only left and right handed kits comply with dimensional requirements of AS 1428.1-2009 but all comply with clause 17 of 1428.1-2009 for Design and Construction.



	Code	Finish	Without GST	With GST	GST Free	Features
	<b>HS 018 KIT 16 Please specify left or right or centre fix</b>					
	HS 018-16 CW	Chrome/White 1.5 m hose and handpiece				700 mm x 1100 mm Satin Supreme™ grade 304 inverted "T" grab rail, assembled with <b>HYGIENIC SEAL®</b> healthsafe flange covers and <b>ABS GLIDE SLIDE CRADLE</b> fastened and tensioned to the grab rail for handset support and movement. Also includes a strong and stylish handpiece, PVC reinforced Soffflex® spiral hose and wall outlet elbow which features 9 L/min Flow Interchange Spigot and separate licenced dual check/non return valves to prevent back siphonage.  3 Star - 9 L/min rated as per WELS licence number 0046. Complies with requirements for a 2 walled shower enclosure as per AS 1428.1-2009.  <b>Left and right hand models only comply to AS 1428.1</b>
	HS 018-16 C	Chrome 1.5 m hose and handpiece				
	HS 018-16 CW2	Chrome/White 2 m hose and handpiece				
	HS 018-16 C2	Chrome 2 m hose and handpiece				
	<b>HS 018 KIT 20 Please specify left or right or centre fix</b>					
	HS 018-20 CW	Chrome/White 1.5 m hose and handpiece				700 mm x 1100 mm Satin Supreme™ grade 304 inverted "T" grab rail, assembled with <b>HYGIENIC SEAL®</b> healthsafe flange covers and <b>BRASS FRICTION SLIDE CRADLE</b> fastened and tensioned to the grab rail for handset support and movement. Also includes a strong and stylish handpiece, PVC reinforced Soffflex® spiral hose and wall outlet elbow which features 9 L/min Flow Interchange Spigot and separate licenced dual check/non return valves to prevent back siphonage.  3 Star - 9 L/min rated as per WELS licence number 0046.  <b>Left and right hand models only comply to AS 1428.1</b>
	HS 018-20 C	Chrome 1.5 m hose and handpiece				
	HS 018-20 CW2	Chrome/White 2 m hose and handpiece				
	HS 018-20 C2	Chrome 2 m hose and handpiece				
	<b>HS 018 KIT 21 Please specify left or right hand</b>					
	HS 018-21 CW	Chrome/White 1.5 m hose and handpiece				1170 mm x 1100 mm Satin Supreme™ grade 304 inverted "T" grab rail, assembled with <b>HYGIENIC SEAL®</b> healthsafe flange covers and <b>BRASS FRICTION SLIDE CRADLE</b> fastened and tensioned to the grab rail for handset support and movement. Also includes a strong and stylish handpiece, PVC reinforced Soffflex® spiral hose and wall outlet elbow which features 9 L/min Flow Interchange Spigot and separate licenced dual check/non return valves to prevent back siphonage.  3 Star - 9 L/min rated as per WELS licence number 0046. Complies with requirements for a 2 walled shower enclosure as per AS 1428.1-2009.
	HS 018-21 C	Chrome 1.5 m hose and handpiece				
	HS 018-21 CW2	Chrome/White 2 m hose and handpiece				
	HS 018-21 C2	Chrome 2 m hose and handpiece				
	<b>HS 018 KIT 22 A.B.C. WASH DOWN KIT</b>					
	HS 018-22 CB	Chrome/Black Silver braid 900 mm hose				A - Automobiles, B - Boats, C - Childcare Centres. The Colt trigger wash down gun with on/off lock function adjusts to variable spray patterns. Supplied with PVC heavy duty reinforced smooth hose, right angled wall mount gun nozzle cradle and wall outlet elbow which features 9 L/min Flow Interchange Spigot and separate licenced dual check/non-return valve to prevent back siphonage.  <b>PLEASE NOTE:</b> The colt has a maximum operating pressure of 550 kPa (80PSI) with maximum operating temperature of 55°C. <b>NOT TO BE USED AS LINE END STOP CONTROL.</b>
	HS 018-22 CB1	Chrome/Black Silver braid 1.5 mm mm hose				
	HS 018-22 CB2	Chrome/Black Silver braid 2 mm mm hose				
	HS 018-22 CB3	Chrome/Black Silver braid 3 m hose				





# STANDARD HOSFAB® - HEALTHCARE SHOWER KIT WITH ABS GLIDE SLIDE CRADLE

900 mm Polished Supreme 304 grab rail/shower kit, assembled with 50 mm **HYGIENIC SEAL®** healthsafe flange covers and ABS GLIDE SLIDE CRADLE fastened and tensioned to the grab rail for handset support and movement. The **HYGIENIC SEAL®** healthsafe flange covers with Thermoplastic Elastomer (TPE) fitted seal prevent grime such as soap scum, body fluids, ointments and aqueous based fluids accumulating behind the grab rail flange and creating possible serious health issues. Putting health and hygiene foremost, the grab rails comply with clause 17 of AS 1428.1-2009 for Design and Construction.



## MODEL SHOWN GS 900 F - STANDARD HOSFAB® KIT



Stainless steel screws and wall plugs provided.



Hygienic seal

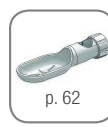

p. 62

Optional extra: SD 032 Soap Dish



Lic. no. 0046





# STANDARD HOSFAB® - SELECTIONS

## 900 mm WITH ABS GLIDE SLIDE CRADLE

Home and healthcare shower selections with 900 mm Polished Supreme grade 304 grab rail, assembled with the highest quality tested products and materials and feature dual check facilities as per AS/NZ 3500. Suits installations in hospitals, homes for the elderly, nursing homes, private and public facilities. Selections comply with clause 17 of AS 1428.1-2009 for Design and Construction.



	Code	Finish	GST Free	Features
<b>GS 900 C CHAMPAGNE PULSATOR</b>				
	GS 900 C-C	Polish Supreme™		<p>900 mm Polished Supreme™ grade 304 grab rail, assembled with <b>HYGIENIC SEAL®</b> healthsafe flange covers with <b>ABS Glide Slide Cradle</b> fastened and tensioned to the grab rail for handset support and movement. Kit includes ABS Champagne Pulsator handpiece, PVC 1.5 m reinforced Softflex® spiral hose and wall outlet elbow which features 9 L/min Flow Interchange Spigot and separate licenced dual check/non-return valves to prevent back siphonage.</p> <p>3 Star - 9 L/min rated as per WELS licence number 0046.</p> <p>Complies with requirements for a 2 walled shower enclosure when installed with HS 700 PS as per AS 1428.1-2009.</p>
	GS 900 C-WTC	White/Chrome		
	GS 900 C-WTG	White/Gold		
	GS 900 C-SC	Satin Completely		
	GS 900 C-CG	Chrome/Gold		
	GS 900 C-G	Gold		
<b>GS 900 P PRINCESS</b>				
	GS 900 P-C	Polish Supreme™		<p>900 mm Polished Supreme™ grade 304 grab rail, assembled with <b>HYGIENIC SEAL®</b> healthsafe flange covers with <b>ABS Glide Slide Cradle</b> fastened and tensioned to the grab rail for handset support and movement. Kit includes ABS Princess handpiece, PVC 1.5 m reinforced Softflex® spiral hose and wall outlet elbow which features 9 L/min Flow Interchange Spigot and separate licenced dual check/non-return valves to prevent back siphonage.</p> <p>3 Star - 9 L/min rated as per WELS licence number 0046.</p> <p>Complies with requirements for a 2 walled shower enclosure when installed with HS 700 PS as per AS 1428.1-2009.</p>
	GS 900 P-ACC	Colour/Chrome		
	GS 900 P-ACG	Colour/Gold		
	GS 900 P-CG	Chrome/Gold		
	GS 900 P-G	Gold		
<b>GS 900 F HOSFAB</b>				
	GS 900 F-C	Polish Supreme™		<p>900 mm Polished Supreme™ grade 304 grab rail, assembled with <b>HYGIENIC SEAL®</b> healthsafe flange covers with <b>ABS Glide Slide Cradle</b> fastened and tensioned to the grab rail for handset support and movement. Kit includes ABS Hosfab handpiece, PVC 1.5 m reinforced Softflex® spiral hose and wall outlet elbow which features 9 L/min Flow Interchange Spigot and separate licenced dual check/non-return valves to prevent back siphonage.</p> <p>3 Star - 9 L/min rated as per WELS licence number 0046.</p> <p>Complies with requirements for a 2 walled shower enclosure when installed with HS 700 PS as per AS 1428.1-2009.</p>
	GS 900 F-WTC	White/Chrome		





# STANDARD HOSFAB® - SELECTIONS

## 700 mm x 1100 mm WITH ABS GLIDE SLIDE CRADLE

Home and healthcare shower selections with 700 mm x 1100 mm Polished Supreme grade 304 inverted "T" grab rail, assembled with the highest quality tested products and materials and feature dual check facilities as per AS/NZ 3500.

Suits installations in hospitals, homes for the elderly, nursing homes, private and public facilities. Only left and right handed kits comply with dimensional requirements of AS 1428.1-2009 but all comply with clause 17 of 1428.1-2009 for Design and Construction.



	Code	Finish	GST Free	Features
<b>GS 071 C CHAMPAGNE PULSATOR</b> Please specify left or right or centre fix				
<p>Drawn left hand</p> <p>Drawn right hand</p> <p>Drawn centre fix</p>	GS 071 C-C	Polish Supreme™		700 mm x 1100 mm Polished Supreme™ inverted "T" grab rail, assembled with <b>HYGIENIC SEAL®</b> healthsafe flange covers and <b>ABS Glide Slide Cradle</b> fastened and tensioned to the grab rail for handset support and movement. Kit includes ABS Champagne Pulsator handpiece, PVC 1.5 m reinforced Soffflex® spiral hose and wall outlet elbow which features 9 L/min Flow Interchange Spigot and separate licenced dual check/non return valves to prevent back siphonage.  3 Star - 9 L/min rated as per WELS licence number 0046.  <b>Left and right hand models only comply to AS 1428.1</b>
	GS 071 C-WTC	White/Chrome		
	GS 071 C-WTG	White/Gold		
	GS 071 C-CG	Chrome/Gold		
<b>GS 071 P PRINCESS</b> Please specify left or right or centre fix				
<p>Drawn left hand</p> <p>Drawn right hand</p> <p>Drawn centre fix</p>	GS 071 P-C	Polish Supreme™		700 mm x 1100 mm Polished Supreme™ inverted "T" grab rail, assembled with <b>HYGIENIC SEAL®</b> healthsafe flange covers and <b>ABS Glide Slide Cradle</b> fastened and tensioned to the grab rail for handset support and movement. Kit includes ABS Princess handpiece, PVC 1.5 m reinforced Soffflex® spiral hose and wall outlet elbow which features 9 L/min Flow Interchange Spigot and separate licenced dual check/non return valves to prevent back siphonage.  3 Star - 9 L/min rated as per WELS licence number 0046.  <b>Left and right hand models only comply to AS 1428.1</b>
	GS 071 P-ACC	Colour/Chrome		
	GS 071 P-ACG	Colour/Gold		
	GS 071 P-CG	Chrome/Gold		
<b>GS 071 F HOSFAB</b> Please specify left or right or centre fix				
<p>Drawn left hand</p> <p>Drawn right hand</p> <p>Drawn centre fix</p>	GS 071 F-C	Polish Supreme™		700 mm x 1100 mm Polished Supreme™ inverted "T" grab rail, assembled with <b>HYGIENIC SEAL®</b> healthsafe flange covers and <b>ABS Glide Slide Cradle</b> fastened and tensioned to the grab rail for handset support and movement. Kit includes ABS Hosfab® handpiece, PVC 1.5 m reinforced Soffflex® spiral hose and wall outlet elbow which features 9 L/min Flow Interchange Spigot and separate licenced dual check/non return valves to prevent back siphonage.  3 Star - 9 L/min rated as per WELS licence number 0046.  <b>Left and right hand models only comply to AS 1428.1</b>
	GS 071 F-WTC	White/Chrome		











# STANDARD HOSFAB® - SELECTIONS

## 1170 mm x 1100 mm WITH ABS GLIDE SLIDE CRADLE

Home and healthcare shower selections with 1170 mm x 1100 mm Polished Supreme grade 304 inverted "T" grab rail, assembled with the highest quality tested products and materials and feature dual check facilities as per AS/NZ 3500. Suits installations in hospitals, homes for the elderly, nursing homes, private and public facilities. Complies with dimensional requirements of 1428.1-2009 and Clause 17 of 1428.1-2009 for Design and Construction.



	Code	Finish	GST Free	Features	
<b>GS 191 C CHAMPAGNE PULSATOR</b> Please specify left or right hand					
 <p>Drawn left hand</p>	GS 191 C-C	Polish Supreme™		1170 mm x 1100 mm Polished Supreme™ inverted "T" grab rail, assembled with HYGIENIC SEAL® healthsafe flange covers and <b>ABS Glide Slide Cradle</b> fastened and tensioned to the grab rail for handset support and movement. Kit includes ABS Champagne Pulsator handpiece, PVC 1.5 m reinforced Softflex® spiral hose and wall outlet elbow which features 9 L/min Flow Interchange Spigot and separate licenced dual check/non return valves to prevent back siphonage.	
	GS 191 C-WTC	White/Chrome			
	GS 191 C-WTG	White/Gold			
	GS 191 C-CG	Chrome/Gold			
 <p>Drawn right hand</p>				3 Star - 9 L/min rated as per WELS licence number 0046.	
<b>GS 191 P PRINCESS</b> Please specify left or right hand					
 <p>Drawn left hand</p>	GS 191 P-C	Polish Supreme™		1170 mm x 1100 mm Polished Supreme™ inverted "T" grab rail, assembled with HYGIENIC SEAL® healthsafe flange covers and <b>ABS Glide Slide Cradle</b> fastened and tensioned to the grab rail for handset support and movement. Kit includes ABS Princess handpiece, PVC 1.5 m reinforced Softflex® spiral hose and wall outlet elbow which features 9 L/min Flow Interchange Spigot and separate licenced dual check/non return valves to prevent back siphonage.	
	GS 191 P-ACC	Colour/Chrome			
	GS 191 P-ACG	Colour/Gold			
	GS 191 P-CG	Chrome/Gold			
 <p>Drawn right hand</p>				3 Star - 9 L/min rated as per WELS licence number 0046.	
<b>GS 191 F HOSFAB</b> Please specify left or right hand					
 <p>Drawn left hand</p>	GS 191 F-C	Polish Supreme™		1170 mm x 1100 mm Polished Supreme™ inverted "T" grab rail, assembled with HYGIENIC SEAL® healthsafe flange covers and <b>ABS Glide Slide Cradle</b> fastened and tensioned to the grab rail for handset support and movement. Kit includes ABS Hosfab® handpiece, PVC 1.5 m reinforced Softflex® spiral hose and wall outlet elbow which features 9 L/min Flow Interchange Spigot and separate licenced dual check/non return valves to prevent back siphonage.	
	GS 191 F-WTC	White/Chrome			
 <p>Drawn right hand</p>				3 Star - 9 L/min rated as per WELS licence number 0046.	





# PREMIUM HOSFAB® - HEALTHCARE SHOWER KIT WITH SLIDE TRACK & HANDSET CRADLE

900 mm Polished Supreme 304 grab rail/shower kit, assembled with 50 mm HYGIENIC SEAL® healthsafe flange covers and 685 mm **FRICTION SLIDE TRACK CRADLE** secured to the grab rail for handset support and movement and most suitable for persons with weakened wrists, arthritic and grip problems. The HYGIENIC SEAL® healthsafe flange covers with Thermoplastic Elastomer (TPE) fitted seal prevent grime such as soap scum, body fluids, ointments and aqueous based fluids accumulating behind the flange cover and creating possible serious health issues. Putting health and hygiene foremost, the grab rails comply with clause 17 of AS 1428.1-2009 for Design and Construction.

MODEL SHOWN GB 900 F - PREMIUM HOSFAB® KIT

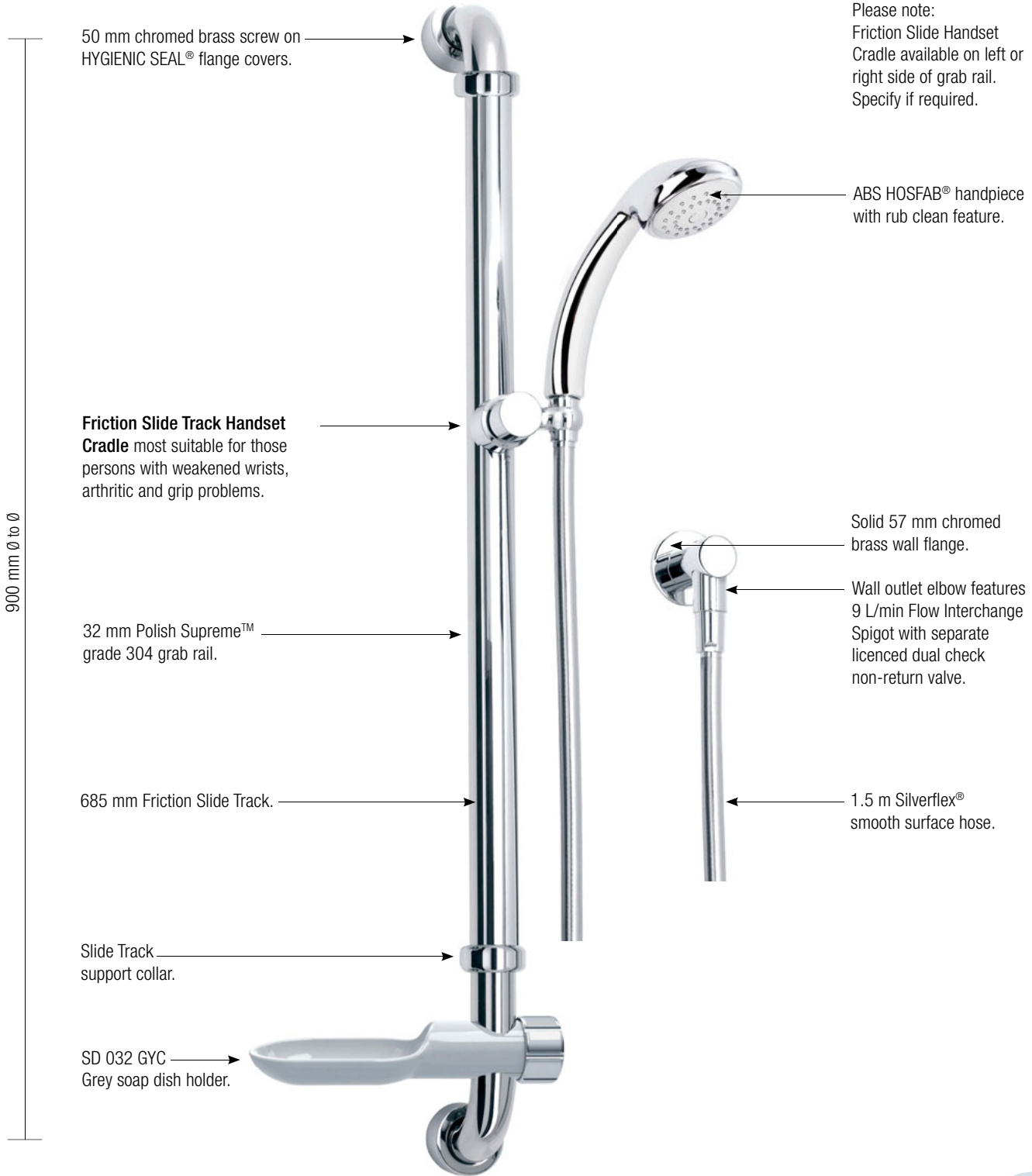

Please note:  
Friction Slide Handset Cradle available on left or right side of grab rail. Specify if required.

900 mm Ø to Ø

Stainless steel screws and wall plugs provided.

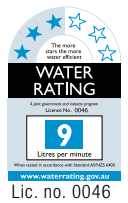





# PREMIUM HOSFAB® - SELECTIONS

## 900 mm WITH FRICTION SLIDE TRACK & CRADLE

Home and healthcare shower selections with 900 mm Polished Supreme grade 304 grab rail, assembled with the highest quality tested products and materials and feature dual check facilities as per AS/NZ 3500. Suits installations in hospitals, homes for the elderly and nursing homes. Selections comply with clause 17 of AS 1428.1-2009 for Design and Construction.



	Code	Finish	GST Free	Features
<b>GB 900 C - CHAMPAGNE PULSATOR</b>				
	GB 900 C-C	Polish Supreme™		900 mm Polished Supreme™ 304 grab rail, assembled with HYGIENIC SEAL® healthsafe flange covers with 685 mm <b>Friction Slide Track and Cradle</b> secured to the grab rail for handset support and movement. Kit includes ABS Champagne pulsator handpiece, PVC 1.5 m Silverflex® or appropriate coloured spiral hose, a grab rail soap dish to suit, wall outlet elbow which features 9 L/min Flow Interchange Spigot and separate licenced dual check/non-return valve to prevent back siphonage.  3 Star - 9 L/min rated as per WELS licence number 0046.
	GB 900 C-WTC	White/Chrome		
	GB 900 C-WTG	White/Gold		
	GB 900 C-SC	Satin Completely		
	GB 900 C-CG	Chrome/Gold		
	GB 900 C-G	Gold		
<b>GB 900 P - PRINCESS</b>				
	GB 900 P-C	Polish Supreme™		900 mm Polished Supreme™ 304 grab rail, assembled with HYGIENIC SEAL® healthsafe flange covers with 685 mm <b>Friction Slide Track and Cradle</b> secured to the grab rail for handset support and movement. Kit includes ABS Princess handpiece, PVC 1.5 m Silverflex® or appropriate coloured spiral hose, a grab rail soap dish to suit, wall outlet elbow which features 9 L/min Flow Interchange Spigot and separate licenced dual check/non-return valve to prevent back siphonage.  3 Star - 9 L/min rated as per WELS licence number 0046.
	GB 900 P-ACC	Colour/Chrome		
	GB 900 P-ACG	Colour/Gold		
	GB 900 P-CG	Chrome/Gold		
	GB 900 P-G	Gold		
<b>GB 900 F - HOSFAB®</b>				
	GB 900 F-C	Polish Supreme™		900 mm Polished Supreme™ 304 grab rail, assembled with HYGIENIC SEAL® healthsafe flange covers with 685 mm <b>Friction Slide Track and Cradle</b> secured to the grab rail for handset support and movement. Kit includes ABS Hosfab® handpiece, PVC 1.5 m Silverflex® or appropriate coloured spiral hose, a grab rail soap dish to suit, wall outlet elbow which features 9 L/min Flow Interchange Spigot and separate licenced dual check/non-return valve to prevent back siphonage.  3 Star - 9 L/min rated as per WELS licence number 0046.
	GB 900 F-WTC	White/Chrome		

















# PREMIUM HOSFAB® - SELECTIONS

## 700 mm x 1100 mm WITH FRICTION SLIDE TRACK & CRADLE

Home and healthcare shower selections with 700 mm x 1100 mm inverted "T" Polished Supreme™ grade 304 grab rail, assembled with the highest quality tested products and materials and feature dual check facilities as per AS/NZ 3500. Suits installations in hospitals, homes for the elderly and nursing homes. Selections comply with clause 17 of AS 1428.1-2009 for Design and Construction.



	Code	Finish	GST Free	Features
<b>GB 071 C - CHAMPAGNE PULSATOR</b> Please specify left or right or centre fix				
 Drawn left hand  Drawn right hand  Drawn centre fix	GB 071 C-C	Polish Supreme™		700 mm x 1100 mm Polished Supreme™ inverted "T" grab rail, assembled with HYGIENIC SEAL® healthsafe flange covers and 685 mm <b>Friction Slide Track and Cradle</b> secured to the grab rail for handset support and movement. Kit includes ABS Champagne Pulsator handpiece, PVC 1.5 m smooth Silverflex® or appropriate coloured spiral hose, a grabrail soap dish, wall outlet elbow which features 9 L/min Flow Interchange Spigot and separate licenced dual check/non return valves to prevent back siphonage.  3 Star - 9 L/min rated as per WELS licence number 0046.
	GB 071 C-WTC	White/Chrome		
	GB 071 C-WTG	White/Gold		
	GB 071 C-CG	Chrome/Gold		
				
<b>GB 071 P - PRINCESS</b> Please specify left or right or centre fix				
 Drawn left hand  Drawn right hand  Drawn centre fix	GB 071 P-C	Polish Supreme™		700 mm x 1100 mm Polished Supreme™ inverted "T" grab rail, assembled with HYGIENIC SEAL® healthsafe flange covers and 685 mm <b>Friction Slide Track and Cradle</b> secured to the grab rail for handset support and movement. Kit includes ABS Princess handpiece, PVC 1.5 m smooth Silverflex® or appropriate coloured spiral hose, a grabrail soap dish, wall outlet elbow which features 9 L/min Flow Interchange Spigot and separate licenced dual check/non return valves to prevent back siphonage.  3 Star - 9 L/min rated as per WELS licence number 0046.
	GB 071 P-ACC	Colour/Chrome		
	GB 071 P-WTG	Colour/Gold		
	GB 071 P-CG	Chrome/Gold		
				
<b>GB 071 F - HOSFAB®</b> Please specify left or right or centre fix				
 Drawn left hand  Drawn right hand  Drawn centre fix	GB 071 F-C	Polish Supreme™		700 mm x 1100 mm Polished Supreme™ inverted "T" grab rail, assembled with HYGIENIC SEAL® healthsafe flange covers and 685 mm <b>Friction Slide Track and Cradle</b> secured to the grab rail for handset support and movement. Kit includes ABS Hosfab® handpiece, PVC 1.5 m smooth Silverflex® or appropriate coloured spiral hose, a grabrail soap dish, wall outlet elbow which features 9 L/min Flow Interchange Spigot and separate licenced dual check/non return valves to prevent back siphonage.  3 Star - 9 L/min rated as per WELS licence number 0046.
	GB 071 F-WTC	White/Chrome		
				











# PREMIUM HOSFAB® - SELECTIONS

## 760 mm x 1000 mm x 1100 mm

### WITH FRICTION SLIDE TRACK & CRADLE

Home and healthcare shower selections with 760 mm x 1000 mm x 1100 mm Polished Supreme grade 304 grab rail, assembled with the highest quality tested products and materials and feature dual check facilities as per AS/NZ 3500. Suits installations in hospitals, homes for the elderly and nursing homes. Selections comply with clause 17 of AS 1428.1-2009 for Design and Construction.





	Code	Finish	GST Free	Features	
<b>GB 711 C - CHAMPAGNE PULSATOR</b>					
<b>Please specify left or right hand</b>					
 <p>Drawn right hand</p>  <p>Drawn left hand</p>	GB 711 C-C	Polish Supreme™		760 mm x 1000 mm x 1100 mm Polished Supreme™ grade 304 grab rail, assembled with HYGIENIC SEAL® healthsafe flange covers with 685 mm <b>Friction Slide Track and Cradle</b> secured to the grab rail for handset support and movement. Kit includes ABS Champagne Pulsator handpiece, PVC 1.5 m smooth Silverflex® or appropriate coloured spiral hose, a grab rail soap dish to suit and wall outlet elbow which features 9 L/min Flow Interchange Spigot and separate licenced dual check/non return valves to prevent back siphonage.	
	GB 711 C-WTC	White/Chrome			3 Star - 9 L/min rated as per WELS licence number 0046.
	GB 711 C-WTG	White/Gold			
	GB 711 C-CG	Chrome/Gold			
					
<b>GB 711 P - PRINCESS</b>					
<b>Please specify left or right hand</b>					
 <p>Drawn right hand</p>  <p>Drawn left hand</p>	GB 711 P-C	Polish Supreme™		760 mm x 1000 mm x 1100 mm Polished Supreme™ grade 304 grab rail, assembled with HYGIENIC SEAL® healthsafe flange covers with 685 mm <b>Friction Slide Track and Cradle</b> secured to the grab rail for handset support and movement. Kit includes ABS Princess handpiece, PVC 1.5 m smooth Silverflex® or appropriate coloured spiral hose, a grab rail soap dish to suit and wall outlet elbow which features 9 L/min Flow Interchange Spigot and separate licenced dual check/non return valves to prevent back siphonage.	
	GB 711 P-ACC	Colour/Chrome			3 Star - 9 L/min rated as per WELS licence number 0046.
	GB 711 P-ACG	Colour/Gold			
	GB 711 P-CG	Chrome/Gold			
					
<b>GB 711 F - HOSFAB®</b>					
<b>Please specify left or right hand</b>					
 <p>Drawn right hand</p>  <p>Drawn left hand</p>	GB 711 F-C	Polish Supreme™		760 mm x 1000 mm x 1100 mm Polished Supreme™ grade 304 grab rail, assembled with HYGIENIC SEAL® healthsafe flange covers with 685 mm <b>Friction Slide Track and Cradle</b> secured to the grab rail for handset support and movement. Kit includes ABS Hosfab® handpiece, PVC 1.5 m smooth Silverflex® or appropriate coloured spiral hose, a grab rail soap dish to suit and wall outlet elbow which features 9 L/min Flow Interchange Spigot and separate licenced dual check/non return valves to prevent back siphonage.	
	GB 711 F-WTC	White/Chrome			3 Star - 9 L/min rated as per WELS licence number 0046.
					



# HEALTHCARE KIT ACCESSORIES

Con-Serv 32 mm grab rail exclusive products.

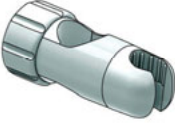
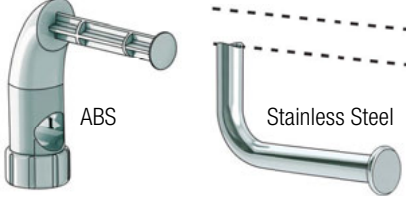
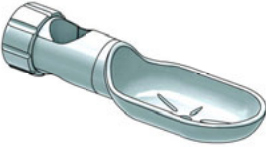
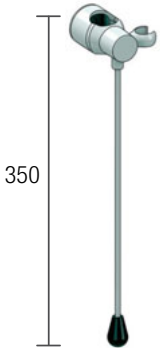

	Code	Finish	With GST	GST Free	Features	
<b>HC 024 - GRAB RAIL GLIDE SLIDE HANDSET CRADLE</b>						
	HC 024 BLC	Black/Chrome			<ul style="list-style-type: none"> <li>Fastens to 32 mm grab rail</li> <li>Clicklock™ claw mechanism</li> <li>ABS construction</li> <li>Simple to clean</li> </ul>	
	HC 024 GYC	Grey/Chrome				
	HC 024 WT	White				
	HC 024 SC	Satin/Chrome				
	HC 024 ACG	Colour/Gold				
<b>TR 031 - GRAB RAIL FLEXIBLE FIX AND STAINLESS STEEL TOILET ROLL HOLDER</b>						
	TR 031 BLC	Black/Chrome			<ul style="list-style-type: none"> <li>Fastens to 32 mm grab rail</li> <li>ABS construction</li> <li>Simple to clean</li> <li>Fits all 32 mm toilet assist grab rails</li> </ul>	
	TR 031 GYC	Grey/Chrome				
	TR 031 WT	White				
	TR 031 SC	Satin/Chrome				
	TR 031 ACG	Colour/Gold				
	TR 031 SS	Stainless Steel				
<b>SD 032 - GRAB RAIL SOAP DISH HOLDER</b>						
	SD 032 BLC	Black/Chrome			<ul style="list-style-type: none"> <li>Fastens to 32 mm grab rail</li> <li>ABS construction</li> <li>Simple to clean</li> </ul>	
	SD 032 GYC	Grey/Chrome				
	SD 032 WT	White				
	SD 032 SC	Satin/Chrome				
	SD 032 ACG	Colour/Gold				
<b>PM 932 - PUSH-PULLME® SHOWER POSITIONING CRADLE WITH ROD</b>						
 <p>350</p>	PM 932 C	Chrome			<p><b>Brass Friction Slide Cradle</b> with PUSH-PULLME® shower height adjustment rod.</p> <p>To comply with requirements of AS 1428.1-2009 for person with disabilities (PWD), an adjustable shower head holder shall be provided to support the shower head and shall allow the graspable portion of the shower head to be positioned at various angles and heights and also allow the graspable portion of the shower head to be located at heights between 1000 mm and 1800 mm above the plane of the finished floor and allow access and adjustment from a seated position. The PUSH-PULLME® suits this requirement.</p> <p><b>FACTORY FITTED</b></p>	
<b>SR 685 - PREMIUM 685 mm FRICTION SLIDE TRACK CRADLE &amp; COLLARS</b>						
 <p>685</p>	SR 685 C	Chrome			<ul style="list-style-type: none"> <li>Brass construction</li> <li>Cradle adjustment for handpiece</li> <li>Smooth slide action</li> <li>Self locking</li> <li>Recommended for those persons with arthritic or grip problems.</li> <li>No locking knob</li> </ul> <p><b>FACTORY FITTED</b></p>	
	SR 685 ACC	Colour/Chrome				
	SR 685 ACG	Colour/Gold				
	SR 685 SC	Satin Completely				
	SR 685 CG	Chrome/Gold				
	SR 685 G	Gold				
<b>HP 049 - COLT WASH DOWN GUN</b>						
	HP 049	Chrome/Black			<p>The colt trigger operated wash down gun with on/off lock function is robustly constructed and is built to last. The Colt has a maximum operating pressure of 550 Kpa (80 PSI) and maximum operating temperature of 55°C. Nozzle adjusts from narrow neck to wide pattern spray.</p> <p><b>NOT TO BE USED AS LINE END STOP CONTROL.</b></p>	



	Code	Finish	GST Free	Features	
<b>HS 032 BE - HYGIENIC SEAL® BLANK END FLANGE</b>					
	HS 032 BE	Chrome		Blank end tamperproof flange to cover Hygienic Seal® wall mount plate when the grab rail is removed, but will be required to be re-installed for use in a PWD requirement.	
<b>HS 032 FC - HYGIENIC SEAL® FLANGE COVER</b>					
	HS 032 FC	Chrome		50 mm Hygienic Seal® flange cover. Follow installation instruction guide, page 65, if replacement is required.  The Hygienic Seal® is a thermodynamic product designed to eliminate the risk of bathroom debris getting behind the flange and becoming unsanitary, thereby causing or conveying infection. The Hygienic Seal® is intended to assist in the promotion of hygiene, particularly in environments where this is a critical issue.	
<b>HS 032 MP - HYGIENIC SEAL® WALL MOUNT PLATE</b>					
	HS 032 MP	Brass		Hygienic Seal® wall screw mount plate. Designed to rotate screw holes to suit stud or nogging.  Stainless steel fixing screws supplied.	
<b>TL 850 WM - TILTLOCK® "T" MOUNT BRACKET</b>					
 <p style="text-align: center;">Right hand      Left hand</p>	TL 850L WM	Brass/Nickle Plate		Concealed 4 fix nickle-plated brass "T" mount bracket secures TILTLOCK® to wall.  Stainless steel fixing screws supplied.	
	TL 850R WM	Brass/Nickle Plate			
<b>TL 850 WC - TILTLOCK® (TPE) "T" MOUNT COVER</b>					
	TL 850 WC	White TPE		Thermo Plastic Elastomer (TPE) mount cover to conceal TILTLOCK® brass "T" mount bracket for when project specifications call for provision to be made for fold down rails to be installed at a further time.	
<b>TL 850 US - TILTLOCK® FLOOR MOUNT UPSTAND</b>					
	TL 850 US	Satin Stainless		Stainless steel floor mount upstand for mounting TILTLOCK® in Bariatric situations and when wall mounting is not possible.  Stainless steel fixing screws supplied.	





## CLAM FLANGE™ Grab Rails



Regular grab rail with 78 mm "CLAM FLANGE", domed cover, for the concealing of screw fixing points of the grab rail mount flange. The CLAM FLANGE™ snaps over notch lugs on the mount flange locking it firmly in place.

Con-Serv CLAM FLANGE™ grab rails are fabricated from 32 mm x 1.2 mm grade 304, 18/8 stainless steel, and pre-formed 75 mm 5 screw wall mount plate with 360 mm rear weld joint. Assembled with 78 mm domed CLAM FLANGE™ cover with 5 degree radius to comply with clause 17 of AS 1428.1-2009 for Design and Construction and available in the following finishes: Satin Supreme™, Polish Supreme™, Diamond Shur-Grip® and colours of choice.

### Grab Rail Specifications

#### Outside Diameter

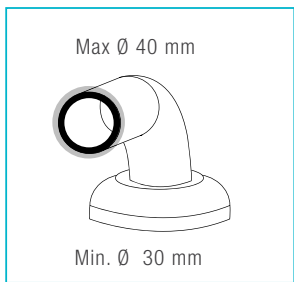

Grab rails should not be less than 30 mm and not more than 40 mm outside diameter, or they shall have sectional shape within the limits of 30 mm and 40 mm diameter.

#### Wall Clearance

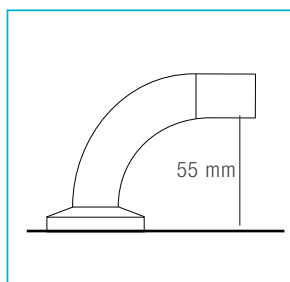

Unless otherwise specified, the clearance between grab rail and the adjacent wall surface or other obstruction shall not be less than 50 mm and not more than 60 mm. This clearance shall extend above the top of the grab rail by not less than 600 mm.

#### Mounting Height

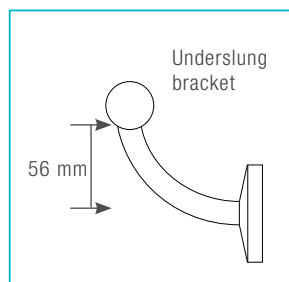

All horizontal fixings to be underslung brackets as per standard requirements.

Con-Serv grab rail underslung bracket is 56 mm below rail.

#### Minimum Obstruction

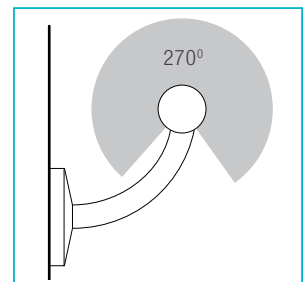

Grab rails shall be fixed so that there is no obstruction to the hand along the top 270 degrees of the rail.

### Installation Instructions for Grab Rail with Clam Flange™

Grab rails with clam flange must be fitted to a solid wall or other firm surface and installed by a qualified trades person.

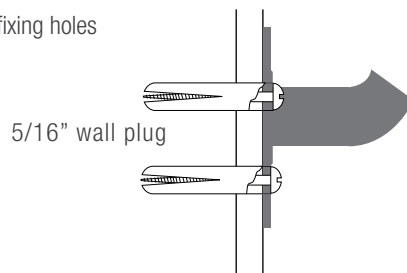
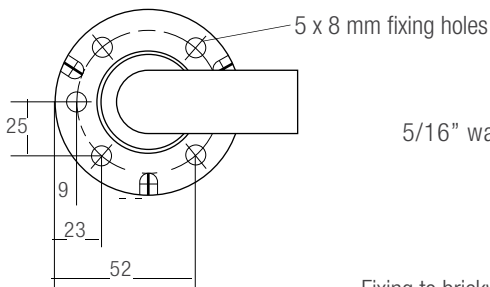

Fixing to brickwork, blockwork or concrete use stainless steel 50 mm x 14 g self tapping screws.

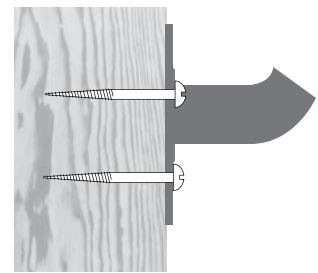

Fixing to timber use stainless steel 50 mm x 14 g self tapping screws.

### Custom Made Grab Rail Measurement Instructions

1. Measure all bends to the centre line.
2. When designing any grab rail all measurements are centre to centre of the rail.
3. Dimensions should be clearly shown between rail centres or to wall corners.
4. For handed grab rails nominate left or right hand e.g. Toilet assist rails are sitting on the pan, not looking at it.

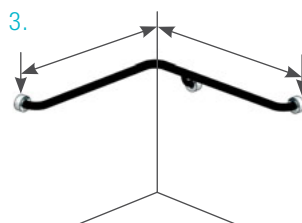
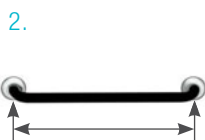
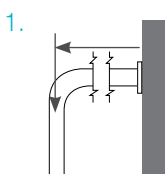

Drawn left hand

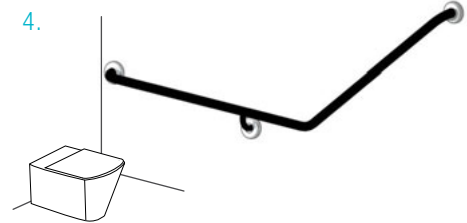

Drawn left hand



## HYGIENIC SEAL® Grab Rails - Independence with Style



When health and hygiene matter most, HYGIENIC SEAL® grab rails lead the healthcare industry with Con-Serv's own, innovation cove designed Thermoplastic Elastomer (TPE) fitted flange seal that firms to the rail wall and when installed prevents grime, such as soap scum, body fluids, ointments and aqueous based fluids accumulating behind the grab rail flange covers and creating possible serious health issues.

**Only Con-Serv® HYGIENIC SEAL® Safe-Assist® Grab Rails give this Promise. Be most cautious of claims made by imitators.**

Con-Serv® HYGIENIC SEAL® Safe-Assist® grab rail collection is fabricated from 32 mm x 1.2 mm, grade 304, 18/8 stainless steel and assembled with a 50 mm, 3 part machined brass screw on flange cover with 5 degree radius to comply with clause 17 of AS 1428.1-2009 for Design and Construction and available in the following finishes: Satin Supreme™, Polish Supreme™, Diamond Shur-Grip® and colour of choice.

Tested by ETRS Pty Ltd for compliance to 1100 N mass in any position, without any permanent deformation, distortion or loosening of the fastenings. Test report registration number QRN00-2847.

### Installation Guide

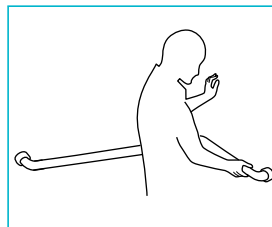

1. Install straight grab rails including the horizontal section of any grab rails as per AS 1428, 800-810 mm from floor to top of rail. Make sure wall surface is flat and free from contaminants.

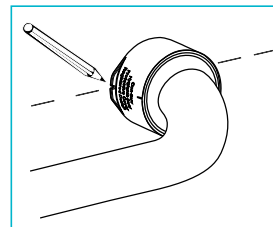

2. For STRAIGHT grab rails, position the flange protector guide lugs either vertical or horizontal. For CORNER grab rails, position the guide lugs horizontally "ONLY". Then mark at fixing guide lugs.

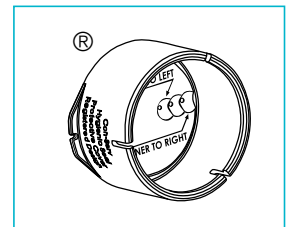

3. Remove flange protector from grab rail flange, align guide lug marks from step 2 and mark wall through base holes to pinpoint screw holes.

Design Registration number - 311119.

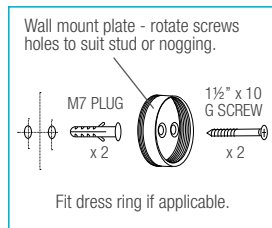

4. Drill spot marks with 7 mm bit. Plug and screw wall mount plate to wall stud, using the 304 stainless steel screws supplied.

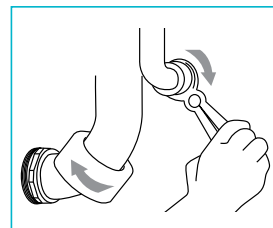

5. Fit grab rail into wall mount plate and tighten lock nut firmly.

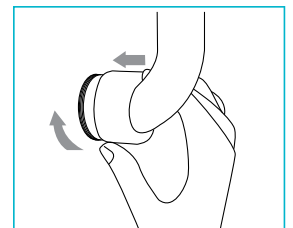

6. Screw flange cover to wall mount plate, to secure the Thermoplastic Elastomer fitted HYGIENIC SEAL®

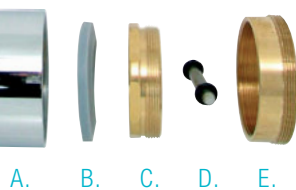

- A. Flange cover
- B. Thermoplastic Elastomer (the seal)
- C. Locking nut
- D. Locking pin
- E. Screw mount plate

Grab rails and shower support rails are installed to provide safe support for persons who require assistance in toilets as well as bathrooms and should comply on installation when fixed, to contribute to its ability to withstand the required 1100 Newton force placed upon it. Concrete or brick walls do not present a problem. If a building is constructed with either metal frame or timber it is useful to know the dimensions of the studs and noggings and the place between the studs. Con-Serv® HYGIENIC SEAL® wall mount fittings have two screw holes and can be positioned and fastened at any angle to suit the stud or nogging. TOGGLE BOLTS FIXED INTO TILES, PLASTER BOARD OR OTHER WATERPROOF WALLS ARE NOT SATISFACTORY OR SAFE. Grab rails with HYGIENIC SEAL® flange must be fitted to a solid wall or other firm surface and installed by a qualified trades person.



# REGULAR - STRAIGHT GRAB RAILS

**CLAM FLANGE™** Safe-Assist® 32 mm grab rails, fabricated from 304 stainless steel with 78 mm pre-formed domed Clam concealed flange. Manufactured to comply with clause 17 of AS 1428.1-2009 for design and construction. For horizontal fixing of grab rails, mount 800 mm to 810 mm above floor level.













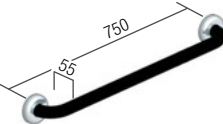

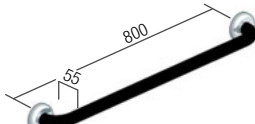
	Code	Finish	GST Free	Features
<b>300 mm</b>				
	CF 300 SS	Satin Supreme™		300 mm Ø to Ø Stainless steel fixing screws supplied.  
	CF 300 PS	Polish Supreme™		
	CF 300 KG	Diamond Shur-Grip®		
	CF 300 FC	Full Colour		
<b>400 mm</b>				
	CF 400 SS	Satin Supreme™		400 mm Ø to Ø Stainless steel fixing screws supplied.  
	CF 400 PS	Polish Supreme™		
	CF 400 KG	Diamond Shur-Grip®		
	CF 400 FC	Full Colour		
<b>450 mm</b>				
	CF 450 SS	Satin Supreme™		450 mm Ø to Ø Stainless steel fixing screws supplied.  
	CF 450 PS	Polish Supreme™		
	CF 450 KG	Diamond Shur-Grip®		
	CF 450 FC	Full Colour		
<b>500 mm</b>				
	CF 500 SS	Satin Supreme™		500 mm Ø to Ø Stainless steel fixing screws supplied.  
	CF 500 PS	Polish Supreme™		
	CF 500 KG	Diamond Shur-Grip®		
	CF 500 FC	Full Colour		
<b>600 mm</b>				
	CF 600 SS	Satin Supreme™		600 mm Ø to Ø Stainless steel fixing screws supplied.  
	CF 600 PS	Polish Supreme™		
	CF 600 KG	Diamond Shur-Grip®		
	CF 600 FC	Full Colour		
<b>700 mm</b>				
	CF 700 SS	Satin Supreme™		700 mm Ø to Ø Stainless steel fixing screws supplied.  
	CF 700 PS	Polish Supreme™		
	CF 700 KG	Diamond Shur-Grip®		
	CF 700 FC	Full Colour		

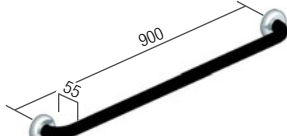

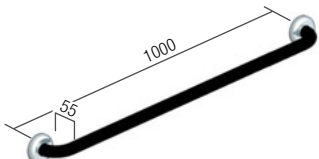
# REGULAR - STRAIGHT GRAB RAILS

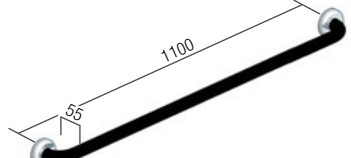
**CLAM FLANGE™** Safe-Assist® 32 mm grab rails, fabricated from 304 stainless steel with 78 mm pre-formed domed Clam concealed flange. Manufactured to comply with clause 17 of AS 1428.1-2009 for design and construction. For horizontal fixing of grab rails, mount 800 mm to 810 mm above floor level.

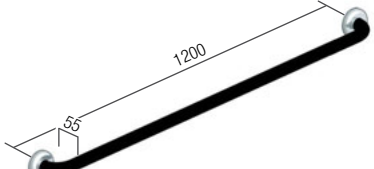

	Code	Finish	GST Free	Features
<b>750 mm</b>				
	CF 750 SS	Satin Supreme™		750 mm Ø to Ø Stainless steel fixing screws supplied  
	CF 750 PS	Polish Supreme™		
	CF 750 KG	Diamond Shur-Grip®		
	CF 750 FC	Full Colour		
<b>800 mm</b>				
	CF 800 SS	Satin Supreme™		800 mm Ø to Ø Stainless steel fixing screws supplied.  
	CF 800 PS	Polish Supreme™		
	CF 800 KG	Diamond Shur-Grip®		
	CF 800 FC	Full Colour		
<b>900 mm</b>				
	CF 900 SS	Satin Supreme™		900 mm Ø to Ø Stainless steel fixing screws supplied.  
	CF 900 PS	Polish Supreme™		
	CF 900 KG	Diamond Shur-Grip®		
	CF 900 FC	Full Colour		
<b>1000 mm</b>				
	CF 1000 SS	Satin Supreme™		1000 mm Ø to Ø Stainless steel fixing screws supplied.  
	CF 1000 PS	Polish Supreme™		
	CF 1000 KG	Diamond Shur-Grip®		
	CF 1000 FC	Full Colour		
<b>1100 mm</b>				
	CF 1100 SS	Satin Supreme™		1100 mm Ø to Ø Stainless steel fixing screws supplied.  
	CF 1100 PS	Polish Supreme™		
	CF 1100 KG	Diamond Shur-Grip®		
	CF 1100 FC	Full Colour		
<b>1200 mm</b>				
	CF 1200 SS	Satin Supreme™		1200 mm Ø to Ø Stainless steel fixing screws supplied.  
	CF 1200 PS	Polish Supreme™		
	CF 1200 KG	Diamond Shur-Grip®		
	CF 1200 FC	Full Colour		



Optional extras: Toilet Roll Holders



TR 031

TR 031 SS

Refer page 62

# REGULAR - AMBULANT & TOILET GRAB RAILS

**CLAM FLANGE™** Safe-Assist® 32 mm grab rails, fabricated from 304 stainless steel with 78 mm pre-formed domed Clam concealed flange. Manufactured to comply with clause 17 of AS 1428.1-2009 for design and construction. For horizontal fixing of grab rails, mount 800 mm to 810 mm above floor level.



450 mm x 450 mm	Code	Finish	GST Free	Features
<p>Drawn left hand</p>	CF 045 SS	Satin Supreme™		450 mm x 450 mm Stainless steel fixing screws supplied. Suitable for left or right hand installation. 
	CF 045 PS	Polish Supreme™		
	CF 045 KG	Diamond Shur-Grip®		
	CF 045 FC	Full Colour		
<b>450 mm x 700 mm GRAB RAIL REQUIRED EACH SIDE OF TOILET</b> <p>Drawn left hand For ambulant disabilities.</p>	<b>Please specify left or right hand</b>			450 mm x 700 mm Complies with requirements of AS 1428.1-2009 for water closets. Stainless steel fixing screws supplied. 
	CF 457 SS	Satin Supreme™		
	CF 457 PS	Polish Supreme™		
	CF 457 KG	Diamond Shur-Grip®		
<b>700 mm x 700 mm</b> <p>Drawn left hand</p>	<b>Please specify left or right hand</b>			700 mm x 700 mm Stainless steel fixing screws supplied. 
	CF 077 SS	Satin Supreme™		
	CF 077 PS	Polish Supreme™		
	CF 077 KG	Diamond Shur-Grip®		
<b>870 mm x 700 mm</b> <p>Drawn left hand</p>	<b>Please specify left or right hand</b>			870 mm x 700 mm Complies with requirements of AS 1428.1-2009 for water closets. Stainless steel fixing screws supplied. 
	CF 877 SS	Satin Supreme™		
	CF 877 PS	Polish Supreme™		
	CF 877 KG	Diamond Shur-Grip®		
<b>940 mm x 700 mm</b> <p>Drawn left hand <b>Note: Horizontal flange connects directly to rear wall.</b></p>	<b>Please specify left or right hand</b>			940 mm x 700 mm Complies with requirements of AS 1428.1-2009 for water closets. Stainless steel fixing screws supplied. 
	CF 947 SS	Satin Supreme™		
	CF 947 PS	Polish Supreme™		
	CF 947 KG	Diamond Shur-Grip®		
<b>1110 mm x 940 mm x 700 mm</b> <p>Drawn left hand <b>Suits Backrest installation</b></p>	<b>Please specify left or right hand</b>			1110 mm x 940 mm x 700 mm centre to wall corner Complies with requirements of AS 1428.1-2009 for water closets. Stainless steel fixing screws supplied. 
	CF 197 SS	Satin Supreme™		
	CF 197 PS	Polish Supreme™		
	CF 197 KG	Diamond Shur-Grip®		





# REGULAR - AMBULANT & TOILET GRAB RAILS

**CLAM FLANGE™** Safe-Assist® 32 mm grab rails, fabricated from 304 stainless steel with 78 mm pre-formed domed Clam concealed flange. Manufactured to comply with clause 17 of AS 1428.1-2009 for design and construction. For horizontal fixing of grab rails, mount 800 mm to 810 mm above floor level.

Optional extras: Toilet Roll Holders



TR 031 TR 031 SS  
Refer page 62



	Code	Finish	GST Free	Features
<b>450 mm x 450 mm</b>				
<p>Drawn left hand</p> <p><b>For ambulant disabilities</b></p>	CF 454 SS	Satin Supreme™		450 mm x 450 mm Complies with requirements of AS 1428.1-2009 for water closets. Stainless steel fixing screws supplied.
	CF 454 PS	Polish Supreme™		
	CF 454 KG	Diamond Shur-Grip®		
	CF 454 FC	Full Colour		
<b>400 mm x 600 mm</b>				
<p>Drawn left hand</p>	<b>Please specify left or right hand</b>			
	CF 046 SS	Satin Supreme™		400 mm x 600 mm Stainless steel fixing screws supplied.
	CF 046 PS	Polish Supreme™		
	CF 046 KG	Diamond Shur-Grip®		
	CF 046 FC	Full Colour		
<b>600 mm x 600 mm</b>				
<p>Drawn left hand</p>	<b>Please specify left or right hand</b>			
	CF 606 SS	Satin Supreme™		600 mm x 600 mm Stainless steel fixing screws supplied.
	CF 606 PS	Polish Supreme™		
	CF 606 KG	Diamond Shur-Grip®		
	CF 606 FC	Full Colour		
<b>960 mm x 600 mm</b>				
<p>Drawn left hand</p>	<b>Please specify left or right hand</b>			
	CF 966 SS	Satin Supreme™		960 mm x 600 mm Complies with requirements of AS 1428.1-2009 for water closets. Stainless steel fixing screws supplied.
	CF 966 PS	Polish Supreme™		
	CF 966 KG	Diamond Shur-Grip®		
	CF 966 FC	Full Colour		
<b>1030 mm x 600 mm</b>				
<p>Drawn left hand</p> <p><b>Note: Horizontal flange connects directly to rear wall.</b></p>	<b>Please specify left or right hand</b>			
	CF 106 SS	Satin Supreme™		1030 mm x 600 mm Complies with requirements of AS 1428.1-2009 for water closets. Stainless steel fixing screws supplied.
	CF 106 PS	Polish Supreme™		
	CF 106 KG	Diamond Shur-Grip®		
	CF 106 FC	Full Colour		
<b>1110 mm x 1030 mm x 600 mm</b>				
<p>Drawn left hand</p> <p><b>Suits Backrest installation</b></p>	<b>Please specify left or right hand</b>			
	CF 116 SS	Satin Supreme™		1110 mm x 1030 mm x 600 mm centre to wall corner Complies with requirements of AS 1428.1-2009 for water closets. Stainless steel fixing screws supplied.
	CF 116 PS	Polish Supreme™		
	CF 116 KG	Diamond Shur-Grip®		
	CF 116 FC	Full Colour		



# REGULAR - CORNER GRAB RAILS

**CLAM FLANGE™** Safe-Assist® 32 mm grab rails, fabricated from 304 stainless steel with 78 mm pre-formed domed Clam concealed flange. Manufactured to comply with clause 17 of AS 1428.1-2009 for design and construction. For horizontal fixing of grab rails, mount 800 mm to 810 mm above floor level.



	Code	Finish	GST Free	Features
<b>600 mm x 600 mm</b>  Drawn left hand	<b>Please specify left or right hand</b>			
	CF 660 SS	Satin Supreme™		<b>MADE TO ORDER NON-RETURNABLE</b>  600 mm x 600 mm centre to wall corner Stainless steel fixing screws supplied.  
	CF 660 PS	Polish Supreme™		
	CF 660 KG	Diamond Shur-Grip®		
	CF 660 FC	Full Colour		
<b>700 mm x 700 mm</b>  Drawn left hand	<b>Please specify left or right hand</b>			
	CF 770 SS	Satin Supreme™		<b>MADE TO ORDER NON-RETURNABLE</b>  700 mm x 700 mm centre to wall corner Stainless steel fixing screws supplied.  
	CF 770 PS	Polish Supreme™		
	CF 770 KG	Diamond Shur-Grip®		
	CF 770 FC	Full Colour		
<b>750 mm x 750 mm</b>  Drawn left hand	<b>Please specify left or right hand</b>			
	CF 757 SS	Satin Supreme™		<b>MADE TO ORDER NON-RETURNABLE</b>  750 mm x 750 mm centre to wall corner Stainless steel fixing screws supplied.  
	CF 757 PS	Polish Supreme™		
	CF 757 KG	Diamond Shur-Grip®		
	CF 757 FC	Full Colour		
<b>800 mm x 800 mm</b>  Drawn left hand	<b>Please specify left or right hand</b>			
	CF 880 SS	Satin Supreme™		<b>MADE TO ORDER NON-RETURNABLE</b>  800 mm x 800 mm centre to wall corner Stainless steel fixing screws supplied.  
	CF 880 PS	Polish Supreme™		
	CF 880 KG	Diamond Shur-Grip®		
	CF 880 FC	Full Colour		
<b>760 mm x 1000 mm</b>  Drawn left hand	<b>Please specify left or right hand</b>			
	CF 761 SS	Satin Supreme™		760 mm x 1000 mm centre to wall corner Stainless steel fixing screws supplied.  
	CF 761 PS	Polish Supreme™		
	CF 761 KG	Diamond Shur-Grip®		
	CF 761 FC	Full Colour		



# REGULAR - SHOWER RECESS GRAB RAILS

**CLAM FLANGE™** Safe-Assist® 32 mm grab rails, fabricated from 304 stainless steel with 78 mm pre-formed domed Clam concealed flange. Manufactured to comply with clause 17 of AS 1428.1-2009 for design and construction. For horizontal fixing of grab rails, mount 800 mm to 810 mm above floor level.



Optional extra: SD 032 Soap Dish

Code	Finish	GST Free	Features
<b>400 mm x 1100 mm "L" SHAPE</b>			
Please specify left or right hand			
CF 041 SS	Satin Supreme™		<b>MADE TO ORDER NON-RETURNABLE</b>  400 mm x 1100 mm "L" shape grab rail. Stainless steel fixing screws supplied.
CF 041 PS	Polish Supreme™		
CF 041 KG	Diamond Shur-Grip®		
CF 041 FC	Full Colour		
<b>700 mm x 1100 mm INVERTED "T"</b>			
Please specify left or right or centre fix			
CF 071 SS	Satin Supreme™		<b>TO SUIT SINGLE ACCESSIBLE SHOWER RECESS</b>  700 mm x 1100 mm Inverted "T" grab rail. <b>Left and right hand models only comply</b> with AS 1428.1-2009 for a 2 walled shower enclosure. Stainless steel fixing screws supplied.
CF 071 PS	Polish Supreme™		
CF 071 KG	Diamond Shur-Grip®		
CF 071 FC	Full Colour		
<b>1170 mm x 1100 mm INVERTED "T"</b>			
Please specify left or right hand			
CF 191 SS	Satin Supreme™		<b>TO SUIT COMBINED ACCESSIBLE SANITARY COMPARTMENT</b>  1170 mm x 1100 mm Inverted "T" grab rail. Complies with requirements of AS 1428.1-2009 for a 2 walled shower enclosure. Stainless steel fixing screws supplied.
CF 191 PS	Polish Supreme™		
CF 191 KG	Diamond Shur-Grip®		
CF 191 FC	Full Colour		
<b>760 mm x 1000 mm x 1100 mm SHOWER RECESS</b>			
Please specify left or right hand			
CF 711 SS	Satin Supreme™		<b>TO SUIT CORNER SHOWER RECESS</b>  760 mm x 1000 mm x 1100 mm centre to wall corner grab rail. Stainless steel fixing screws supplied.
CF 711 PS	Polish Supreme™		
CF 711 KG	Diamond Shur-Grip®		
CF 711 FC	Full Colour		



# PREMIUM - STRAIGHT GRAB RAILS

**HYGIENIC SEAL®** Safe-Assist® 32 mm grab rails, fabricated from 304 stainless steel and assembled with 50 mm brass screw on flange covers with Thermoplastic Elastomer (TPE) fitted seals. The seals firm to the rail wall and prevent the accumulation of unhealthy grime. The HYGIENIC SEAL® grab rail complies with clause 17 of AS 1428.1-2009 for Design and Construction. Mount grab rail 800 mm to 810 mm above floor level.

	Code	Finish	GST Free	Features
<b>200 mm</b>				
	HS 200 SS	Satin Supreme™		 200 mm Ø to Ø Stainless steel fixing screws supplied.
	HS 200 PS	Polish Supreme™		
	HS 200 KG	Diamond Shur-Grip®		
	HS 200 FC	Full Colour		
	HS 200 GG	Gold		
<b>300 mm</b>				
	HS 300 SS	Satin Supreme™		 300 mm Ø to Ø Stainless steel fixing screws supplied.
	HS 300 PS	Polish Supreme™		
	HS 300 KG	Diamond Shur-Grip®		
	HS 300 AC	Colour/chrome flange covers		
	HS 300 FC	Full colour		
	HS 300 AG	Colour/gold dress rings		
	HS 300 GG	Gold		
<b>400 mm</b>				
	HS 400 SS	Satin Supreme™		 400 mm Ø to Ø Stainless steel fixing screws supplied.
	HS 400 PS	Polish Supreme™		
	HS 400 KG	Diamond Shur-Grip®		
	HS 400 AC	Colour/chrome flange covers		
	HS 400 FC	Full colour		
	HS 400 AG	Colour/gold dress rings		
	HS 400 GG	Gold		
<b>450 mm</b>				
	HS 450 SS	Satin Supreme™		 450 mm Ø to Ø Stainless steel fixing screws supplied.
	HS 450 PS	Polish Supreme™		
	HS 450 KG	Diamond Shur-Grip®		
	HS 450 AC	Colour/chrome flange covers		
	HS 450 FC	Full colour		
	HS 450 AG	Colour/gold dress rings		
	HS 450 GG	Gold		
<b>500 mm</b>				
	HS 500 SS	Satin Supreme™		 500 mm Ø to Ø Stainless steel fixing screws supplied.
	HS 500 PS	Polish Supreme™		
	HS 500 KG	Diamond Shur-Grip®		
	HS 500 AC	Colour/chrome flange covers		
	HS 500 FC	Full colour		
	HS 500 AG	Colour/gold dress rings		
	HS 500 GG	Gold		
<b>600 mm</b>				
	HS 600 SS	Satin Supreme™		 600 mm Ø to Ø Stainless steel fixing screws supplied.
	HS 600 PS	Polish Supreme™		
	HS 600 KG	Diamond Shur-Grip®		
	HS 600 AC	Colour/chrome flange covers		
	HS 600 FC	Full colour		
	HS 600 AG	Colour/gold dress rings		
	HS 600 GG	Gold		
<b>700 mm</b>				
	HS 700 SS	Satin Supreme™		 700 mm Ø to Ø Stainless steel fixing screws supplied.
	HS 700 PS	Polish Supreme™		
	HS 700 KG	Diamond Shur-Grip®		
	HS 700 AC	Colour/chrome flange covers		
	HS 700 FC	Full colour		
	HS 700 AG	Colour/gold dress rings		
	HS 700 GG	Gold		



# PREMIUM - STRAIGHT GRAB RAILS

 **HYGIENIC SEAL®** Safe-Assist® 32 mm grab rails, fabricated from 304 stainless steel and assembled with 50 mm brass screw on flange covers with Thermoplastic Elastomer (TPE) fitted seals. The seals firm to the rail wall and prevent the accumulation of unhealthy grime. The HYGIENIC SEAL® grab rail complies with clause 17 of AS 1428.1-2009 for Design and Construction. Mount grab rail 800 mm to 810 mm above floor level.



	Code	Finish	GST Free	Features
<b>750 mm</b>				
	HS 750 SS	Satin Supreme™		750 mm Ø to Ø Stainless steel fixing screws supplied.  
	HS 750 PS	Polish Supreme™		
	HS 750 KG	Diamond Shur-Grip®		
	HS 750 AC	Colour/chrome flange covers		
	HS 750 FC	Full colour		
	HS 750 AG	Colour/gold dress rings		
	HS 750 GG	Gold		
<b>800 mm</b>				
	HS 800 SS	Satin Supreme™		800 mm Ø to Ø Stainless steel fixing screws supplied.  
	HS 800 PS	Polish Supreme™		
	HS 800 KG	Diamond Shur-Grip®		
	HS 800 AC	Colour/chrome flange covers		
	HS 800 FC	Full colour		
	HS 800 AG	Colour/gold dress rings		
	HS 800 GG	Gold		
<b>900 mm</b>				
	HS 900 SS	Satin Supreme™		900 mm Ø to Ø Stainless steel fixing screws supplied.  
	HS 900 PS	Polish Supreme™		
	HS 900 KG	Diamond Shur-Grip®		
	HS 900 AC	Colour/chrome flange covers		
	HS 900 FC	Full colour		
	HS 900 SC	Satin Chrome		
	HS 900 AG	Colour/gold dress rings		
HS 900 GG	Gold			
<b>1000 mm</b>				
	HS 1000 SS	Satin Supreme™		1000 mm Ø to Ø Stainless steel fixing screws supplied.  
	HS 1000 PS	Polish Supreme™		
	HS 1000 KG	Diamond Shur-Grip®		
	HS 1000 AC	Colour/chrome flange covers		
	HS 1000 FC	Full colour		
	HS 1000 AG	Colour/gold dress rings		
	HS 1000 GG	Gold		
<b>1100 mm</b>				
	HS 1100 SS	Satin Supreme™		1100 mm Ø to Ø Stainless steel fixing screws supplied.  
	HS 1100 PS	Polish Supreme™		
	HS 1100 KG	Diamond Shur-Grip®		
	HS 1100 AC	Colour/chrome flange covers		
	HS 1100 FC	Full colour		
	HS 1100 AG	Colour/gold dress rings		
	HS 1100 GG	Gold		
<b>1200 mm</b>				
	HS 1200 SS	Satin Supreme™		1200 mm Ø to Ø Stainless steel fixing screws supplied.  
	HS 1200 PS	Polish Supreme™		
	HS 1200 KG	Diamond Shur-Grip®		
	HS 1200 AC	Colour/chrome flange covers		
	HS 1200 FC	Full colour		
	HS 1200 AG	Colour/gold dress rings		
	HS 1200 GG	Gold		





Optional extras: Toilet Roll Holders



TR 031

TR 031 SS

Refer page 62

# PREMIUM - AMBULANT & TOILET GRAB RAILS

**HYGIENIC SEAL®** Safe-Assist® 32 mm grab rails. Fabricated from 304 stainless steel and assembled with 50 mm brass screw on flange covers with Thermoplastic Elastomer (TPE) fitted seals. The seals firm to the rail wall and prevent the accumulation of unhealthy grime. The HYGIENIC SEAL® grab rail complies with clause 17 of AS 1428.1-2009 for Design and Construction. Mount horizontal section of rail 800 mm to 810 mm above floor level.



450 mm x 450 mm	Code	Finish	GST Free	Features
<p>Drawn left hand</p>	HS 045 SS	Satin Supreme™		450 mm x 450 mm Stainless steel fixing screws supplied. Suitable for left or right hand installation.
	HS 045 PS	Polish Supreme™		
	HS 045 KG	Diamond Shur-Grip®		
	HS 045 AC	Colour/chrome flange covers		
	HS 045 FC	Full colour		
	HS 045 AG	Colour/gold dress rings		
<b>450 mm x 700 mm</b>				
<p>Drawn left hand For ambulant disabilities.</p>	<b>Please specify left or right hand</b>			
	HS 457 SS	Satin Supreme™		450 mm x 700 mm Complies with requirements of AS 1428.1-2009 for water closets. Stainless steel fixing screws supplied.
	HS 457 PS	Polish Supreme™		
	HS 457 KG	Diamond Shur-Grip®		
	HS 457 AC	Colour/chrome flange covers		
	HS 457 FC	Full colour		
HS 457 AG	Colour/gold dress rings			
<b>700 mm x 700 mm</b>				
<p>Drawn left hand</p>	<b>Please specify left or right hand</b>			
	HS 077 SS	Satin Supreme™		700 mm x 700 mm Stainless steel fixing screws supplied.
	HS 077 PS	Polish Supreme™		
	HS 077 KG	Diamond Shur-Grip®		
	HS 077 AC	Colour/chrome flange covers		
	HS 077 FC	Full colour		
HS 077 AG	Colour/gold dress rings			
<b>870 mm x 700 mm</b>				
<p>Drawn left hand</p>	<b>Please specify left or right hand</b>			
	HS 877 SS	Satin Supreme™		870 mm x 700 mm Complies with requirements of AS 1428.1-2009 for water closets. Stainless steel fixing screws supplied.
	HS 877 PS	Polish Supreme™		
	HS 877 KG	Diamond Shur-Grip®		
	HS 877 AC	Colour/chrome flange covers		
	HS 877 FC	Full colour		
HS 877 AG	Colour/gold dress rings			
<b>940 mm x 700 mm</b>				
<p>Drawn left hand <b>Note: Horizontal flange connects directly to rear wall.</b></p>	<b>Please specify left or right hand</b>			
	HS 947 SS	Satin Supreme™		940 mm x 700 mm Complies with requirements of AS 1428.1-2009 for water closets. Stainless steel fixing screws supplied.
	HS 947 PS	Polish Supreme™		
	HS 947 KG	Diamond Shur-Grip®		
	HS 947 AC	Colour/chrome flange covers		
	HS 947 FC	Full colour		
HS 947 AG	Colour/gold dress rings			
<b>1110 mm x 940 mm x 700 mm</b>				
<p>Drawn left hand <b>Suits Backrest installation</b></p>	<b>Please specify left or right hand</b>			
	HS 197 SS	Satin Supreme™		1110 mm x 940 mm x 700 mm centre to wall corner Complies with requirements of AS 1428.1-2009 for water closets. Stainless steel fixing screws supplied.
	HS 197 PS	Polish Supreme™		
	HS 197 KG	Diamond Shur-Grip®		
	HS 197 AC	Colour/chrome flange covers		
	HS 197 FC	Full colour		
HS 197 AG	Colour/gold dress rings			



Optional extras: Toilet Roll Holders



Refer page 62

# PREMIUM - AMBULANT & TOILET GRAB RAILS

**HYGIENIC SEAL**® Safe-Assist® 32 mm grab rails. Fabricated from 304 stainless steel and assembled with 50 mm brass screw on flange covers with Thermoplastic Elastomer (TPE) fitted seals. The seals firm to the rail wall and prevent the accumulation of unhealthy grime. The HYGIENIC SEAL® grab rail complies with clause 17 of AS 1428.1-2009 for Design and Construction. Mount horizontal section of rail 800 mm to 810 mm above floor level.



Code	Finish	GST Free	Features
<b>450 mm x 450 mm</b>			
<b>Please specify left or right hand</b>			
<p>Drawn left hand</p> <p><b>For ambulant disabilities</b></p>	HS 454 SS	Satin Supreme™	450 mm x 450 mm Complies with requirements of AS 1428.1-2009 for water closets. Stainless steel fixing screws supplied.
	HS 454 PS	Polish Supreme™	
	HS 454 KG	Diamond Shur-Grip®	
	HS 454 AC	Colour/chrome flange covers	
	HS 454 FC	Full colour	
	HS 454 AG	Colour/gold dress rings	
<b>400 mm x 600 mm</b>			
<b>Please specify left or right hand</b>			
<p>Drawn left hand</p>	HS 046 SS	Satin Supreme™	400 mm x 600 mm Stainless steel fixing screws supplied.
	HS 046 PS	Polish Supreme™	
	HS 046 KG	Diamond Shur-Grip®	
	HS 046 AC	Colour/chrome flange covers	
	HS 046 FC	Full colour	
	HS 046 AG	Colour/gold dress rings	
<b>600 mm x 600 mm</b>			
<b>Please specify left or right hand</b>			
<p>Drawn left hand</p>	HS 606 SS	Satin Supreme™	600 mm x 600 mm Stainless steel fixing screws supplied.
	HS 606 PS	Polish Supreme™	
	HS 606 KG	Diamond Shur-Grip®	
	HS 606 AC	Colour/chrome flange covers	
	HS 606 FC	Full colour	
	HS 606 AG	Colour/gold dress rings	
<b>960 mm x 600 mm</b>			
<b>Please specify left or right hand</b>			
<p>Drawn left hand</p>	HS 966 SS	Satin Supreme™	960 mm x 600 mm Complies with requirements of AS 1428.1-2009 for water closets. Stainless steel fixing screws supplied.
	HS 966 PS	Polish Supreme™	
	HS 966 KG	Diamond Shur-Grip®	
	HS 966 AC	Colour/chrome flange covers	
	HS 966 FC	Full colour	
	HS 966 AG	Colour/gold dress rings	
<b>1030 mm x 600 mm</b>			
<b>Please specify left or right hand</b>			
<p>Drawn left hand</p> <p><b>Note: Horizontal flange connects directly to rear wall.</b></p>	HS 106 SS	Satin Supreme™	1030 mm x 600 mm Complies with requirements of AS 1428.1-2009 for water closets. Stainless steel fixing screws supplied.
	HS 106 PS	Polish Supreme™	
	HS 106 KG	Diamond Shur-Grip®	
	HS 106 AC	Colour/chrome flange covers	
	HS 106 FC	Full colour	
	HS 106 AG	Colour/gold dress rings	
<b>1110 mm x 1030 mm x 600 mm</b>			
<b>Please specify left or right hand</b>			
<p>Drawn left hand</p> <p><b>Suits Backrest installation</b></p>	HS 116 SS	Satin Supreme™	1110 mm x 1030 mm x 600 mm centre to wall corner Complies with requirements of AS 1428.1-2009 for water closets. Stainless steel fixing screws supplied.
	HS 116 PS	Polish Supreme™	
	HS 116 KG	Diamond Shur-Grip®	
	HS 116 AC	Colour/chrome flange covers	
	HS 116 FC	Full colour	
	HS 116 AG	Colour/gold dress rings	



# PREMIUM - CORNER GRAB RAILS

**HYGIENIC SEAL®** Safe-Assist® 32 mm grab rails. Fabricated from 304 stainless steel and assembled with 50 mm brass screw on flange covers with Thermoplastic Elastomer (TPE) fitted seals. The seals firm to the rail wall and prevent the accumulation of unhealthy grime. The HYGIENIC SEAL® grab rail complies with clause 17 of AS 1428.1-2009 for Design and Construction. Mount horizontal section of rail 800 mm to 810 mm above floor level.



	Code	Finish	GST Free	Features
<p>Drawn left hand</p>	<b>Please specify left or right hand</b>			
	HS 660 SS	Satin Supreme™		<b>MADE TO ORDER NON-RETURNABLE</b>  600 mm x 600 mm centre to wall corner Stainless steel fixing screws supplied.
	HS 660 PS	Polish Supreme™		
	HS 660 KG	Diamond Shur-Grip®		
	HS 660 AC	Colour/chrome flange covers		
	HS 660 FC	Full colour		
	HS 660 AG	Colour/gold dress rings		
<p>Drawn left hand</p>	<b>Please specify left or right hand</b>			
	HS 770 SS	Satin Supreme™		<b>MADE TO ORDER NON-RETURNABLE</b>  700 mm x 700 mm centre to wall corner Stainless steel fixing screws supplied.
	HS 770 PS	Polish Supreme™		
	HS 770 KG	Diamond Shur-Grip®		
	HS 770 AC	Colour/chrome flange covers		
	HS 770 FC	Full colour		
	HS 770 AG	Colour/gold dress rings		
<p>Drawn left hand</p>	<b>Please specify left or right hand</b>			
	HS 757 SS	Satin Supreme™		<b>MADE TO ORDER NON-RETURNABLE</b>  750 mm x 750 mm centre to wall corner Stainless steel fixing screws supplied.
	HS 757 PS	Polish Supreme™		
	HS 757 KG	Diamond Shur-Grip®		
	HS 757 AC	Colour/chrome flange covers		
	HS 757 FC	Full colour		
	HS 757 AG	Colour/gold dress rings		
<p>Drawn left hand</p>	<b>Please specify left or right hand</b>			
	HS 880 SS	Satin Supreme™		<b>MADE TO ORDER NON-RETURNABLE</b>  800 mm x 800 mm centre to wall corner Stainless steel fixing screws supplied.
	HS 880 PS	Polish Supreme™		
	HS 880 KG	Diamond Shur-Grip®		
	HS 880 AC	Colour/chrome flange covers		
	HS 880 FC	Full colour		
	HS 880 AG	Colour/gold dress rings		
<p>Drawn left hand</p>	<b>Please specify left or right hand</b>			
	HS 761 SS	Satin Supreme™		760 mm x 1000 mm centre to wall corner Stainless steel fixing screws supplied.
	HS 761 PS	Polish Supreme™		
	HS 761 KG	Diamond Shur-Grip®		
	HS 761 AC	Colour/chrome flange covers		
	HS 761 FC	Full colour		
	HS 761 AG	Colour/gold dress rings		









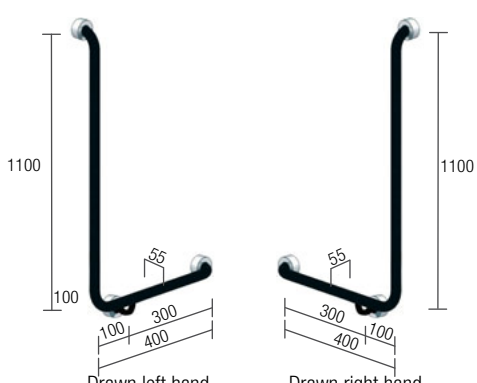

# PREMIUM - SHOWER RECESS GRAB RAILS

 **HYGIENIC SEAL®** Safe-Assist® 32 mm grab rails. Fabricated from 304 stainless steel and assembled with 50 mm brass screw on flange covers with Thermoplastic Elastomer (TPE) fitted seals. The seals firm to the rail wall and prevent the accumulation of unhealthy grime. The HYGIENIC SEAL® grab rail complies with clause 17 of AS 1428.1-2009 for Design and Construction. Mount horizontal section of rail 800 mm to 810 mm above floor level.

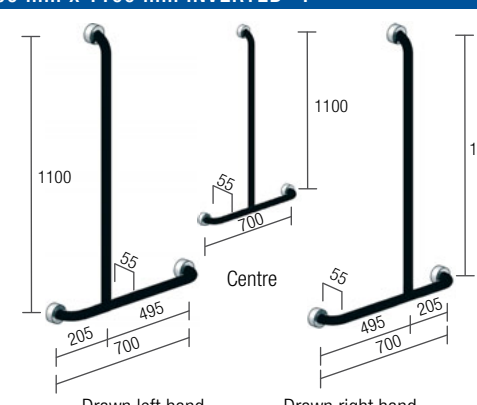

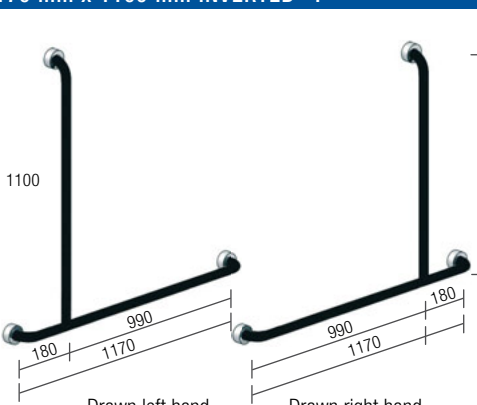
Optional extra: SD 032 Soap Dish

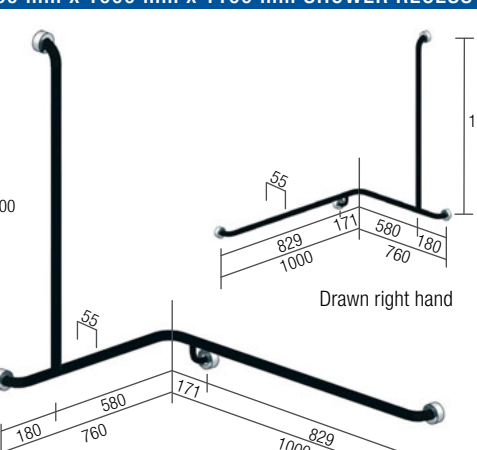





Code	Finish	GST Free	Features
<b>400 mm x 1100 mm "L" SHAPE</b>			
<b>Please specify left or right hand</b>			
HS 041 SS	Satin Supreme™		<b>MADE TO ORDER NON-RETURNABLE</b>  400 mm x 1100 mm "L" shape grab rail. Stainless steel fixing screws supplied.
HS 041 PS	Polish Supreme™		
HS 041 KG	Diamond Shur-Grip®		
HS 041 AC	Colour/chrome flange covers		
HS 041 FC	Full colour		
HS 041 AG	Colour/gold dress rings		
 <p>Drawn left hand      Drawn right hand</p>			
<b>700 mm x 1100 mm INVERTED "T"</b>			
<b>Please specify left or right or centre fix</b>			
HS 071 SS	Satin Supreme™		<b>TO SUIT SINGLE ACCESSIBLE SHOWER RECESS</b>  700 mm x 1100 mm Inverted "T" grab rail. <b>Left and right</b> hand models only comply with AS 1428.1-2009 for a 2 walled shower enclosure. Stainless steel fixing screws supplied.
HS 071 PS	Polish Supreme™		
HS 071 KG	Diamond Shur-Grip®		
HS 071 AC	Colour/chrome flange covers		
HS 071 FC	Full colour		
HS 071 AG	Colour/gold dress rings		
 <p>Drawn left hand      Centre      Drawn right hand</p>			 
<b>1170 mm x 1100 mm INVERTED "T"</b>			
<b>Please specify left or right hand</b>			
HS 191 SS	Satin Supreme™		<b>TO SUIT COMBINED ACCESSIBLE SANITARY COMPARTMENT</b>  1170 mm x 1100 mm Inverted "T" grab rail. Complies with requirements of AS 1428.1-2009 for a 2 walled shower enclosure. Stainless steel fixing screws supplied.
HS 191 PS	Polish Supreme™		
HS 191 KG	Diamond Shur-Grip®		
HS 191 AC	Colour/chrome flange covers		
HS 191 FC	Full colour		
HS 191 AG	Colour/gold dress rings		
 <p>Drawn left hand      Drawn right hand</p>			 
<b>760 mm x 1000 mm x 1100 mm SHOWER RECESS</b>			
<b>Please specify left or right hand</b>			
HS 711 SS	Satin Supreme™		<b>TO SUIT CORNER SHOWER RECESS</b>  760 mm x 1000 mm x 1100 mm centre to wall corner grab rail. Stainless steel fixing screws supplied.
HS 711 PS	Polish Supreme™		
HS 711 KG	Diamond Shur-Grip®		
HS 711 AC	Colour/chrome flange covers		
HS 711 FC	Full Colour		
HS 711 AG	Colour/gold dress rings		
 <p>Drawn left hand      Drawn right hand</p>			



# PREMIUM - GRAB RAIL WITH TOWEL RAIL

**HYGIENIC SEAL®** Safe-Assist 32 mm grab rail with 19 mm towel rail. Fabricated from 304 stainless steel and assembled with 50 mm brass screw on flange covers with Thermoplastic Elastomer (TPE) fitted seals. The seals firm to the rail wall and prevent the accumulation of unhealthy grime. The HYGIENIC SEAL® grab rail complies with clause 17 of AS 1428.1-2009 for Design and Construction. Mount horizontal section of rail 800 mm to 810 mm above floor level.



	Code	Finish	GST Free	Features
<b>600 mm x 19 mm "D" SHAPE</b>				
	HS 619 SS	Satin Supreme™		600 mm "D" shape $\emptyset$ to $\emptyset$ <ul style="list-style-type: none"> <li>Towel rail 19 mm</li> <li>Overall width - 650 mm</li> <li>Overall depth - 161 mm</li> <li>Stainless steel fixing screws supplied.</li> </ul> 
	HS 619 PS	Polish Supreme™		
<b>800 mm x 19 mm "D" SHAPE</b>				
	HS 819 SS	Satin Supreme™		800 mm "D" shape $\emptyset$ to $\emptyset$ <ul style="list-style-type: none"> <li>Towel rail 19 mm</li> <li>Overall width - 850 mm</li> <li>Overall depth - 161 mm</li> <li>Stainless steel fixing screws supplied.</li> </ul> 
	HS 819 PS	Polish Supreme™		
<b>1000 mm x 19 mm "D" SHAPE</b>				
	HS 109 SS	Satin Supreme™		1000 mm "D" shape $\emptyset$ to $\emptyset$ <ul style="list-style-type: none"> <li>Towel rail 19 mm</li> <li>Overall width - 1050 mm</li> <li>Overall depth - 161 mm</li> <li>Stainless steel fixing screws supplied.</li> </ul> 
	HS 109 PS	Polish Supreme™		
<b>1200 mm x 19 mm "D" SHAPE</b>				
	HS 129 SS	Satin Supreme™		1200 mm "D" shape $\emptyset$ to $\emptyset$ <ul style="list-style-type: none"> <li>Towel rail 19 mm</li> <li>Overall width - 1250 mm</li> <li>Overall depth - 161 mm</li> <li>Stainless steel fixing screws supplied.</li> </ul> 
	HS 129 PS	Polish Supreme™		











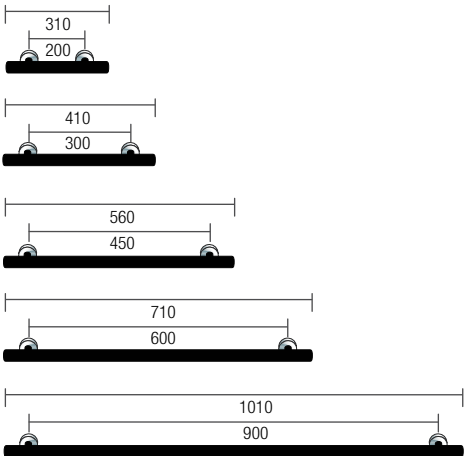

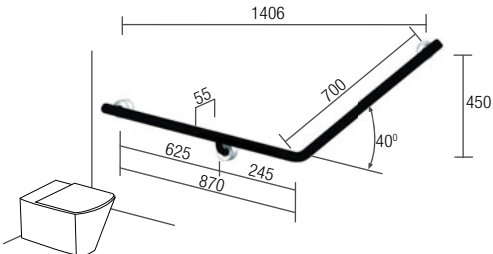

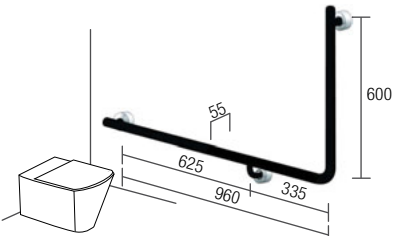

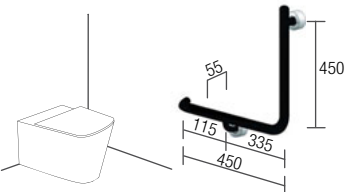
# PREMIUM - LINEAR GRAB RAIL OPTIONS

 **LINEAR** style Safe-Assist® 32 mm grab rails and shower kits. Fabricated from 304 stainless steel and assembled with 50 mm brass screw on "T" leg LINEAR flange with fitted seals which prevent the accumulation of unhealthy grime. The LINEAR grab rails comply with clause 17 of AS 1428.1-2009 for Design and Construction. Mount horizontal section of rail 800 mm to 810 mm above the floor.



	Code	Finish	GST Free	Features
<b>STRAIGHT GRAB RAILS</b>				
	LR 200 SS	Satin Supreme™		200 mm Ø to Ø - Straight grab rail
	LR 200 PS	Polish Supreme™		300 mm Ø to Ø - Straight grab rail
	LR 300 SS	Satin Supreme™		450 mm Ø to Ø - Straight grab rail
	LR 300 PS	Polish Supreme™		600 mm Ø to Ø - Straight grab rail
	LR 450 SS	Satin Supreme™		900 mm Ø to Ø - Straight grab rail
	LR 450 PS	Polish Supreme™		Add 55 mm for each capped extension. Stainless steel fixing screws supplied.
	LR 600 SS	Satin Supreme™		
	LR 600 PS	Polish Supreme™		
LR 900 SS	Satin Supreme™			
LR 900 PS	Polish Supreme™			
<b>870 mm x 700 mm TOILET ASSIST GRAB RAIL</b>				
 <p>Drawn left hand</p>	Please specify left or right hand			
	LR 877 LH SS	Satin Supreme™		870 mm x 700 mm - Toilet assist grab rail Add 55 mm for each capped extension. Complies with requirements of AS 1428.1-2009 for water closets. Stainless steel fixing screws supplied.
	LR 877 RH SS	Satin Supreme™		
	LR 877 LH PS	Polish Supreme™		
	LR 877 RH PS	Polish Supreme™		
				 
<b>960 mm x 600 mm TOILET ASSIST GRAB RAIL</b>				
 <p>Drawn left hand</p>	Please specify left or right hand			
	LR 966 LH SS	Satin Supreme™		960 mm x 600 mm - Toilet assist grab rail Add 55 mm for each capped extension. Complies with requirements of AS 1428.1-2009 for water closets. Stainless steel fixing screws supplied.
	LR 966 RH SS	Satin Supreme™		
	LR 966 LH PS	Polish Supreme™		
	LR 966 RH PS	Polish Supreme™		
				 
<b>450 mm x 450 mm AMBULANT TOILET ASSIST GRAB RAIL</b>				
 <p>Drawn left hand</p>	Please specify left or right hand			
	LR 454 LH SS	Satin Supreme™		450 mm x 450 mm - Ambulant assist grab rail Add 55 mm for each capped extension. Complies with requirements of AS 1428.1-2009 for water closets. Stainless steel fixing screws supplied.
	LR 454 RH SS	Satin Supreme™		
	LR 454 LH PS	Polish Supreme™		
	LR 454 RH PS	Polish Supreme™		
				 
<b>LINEAR GRAB RAIL/SHOWER KIT</b>				
 <p>Brass Friction Slide Cradle</p>	LF 900 J-C	Polish Supreme™		900 mm Polish Supreme™ stainless steel 304 grab rail with <b>Brass Friction Slide Cradle</b> for shower height adjustment. Also includes ABS Streamjet™ handpiece, PVC 1.5 m Silverflex® hose, soap dish and flow regulated wall outlet with licenced dual check. 3 Star - 9 L/min rated as per WELS licence number 0046. Complies with requirements for a 2 walled shower enclosure when installed with HS 700 PS as per AS 1428.1-2009.
			 	



# TILTLOCK® FOLDING RAIL-WAYS®

SAFE-ASSIST® folding grab rails for toilets and showers for use by persons who suffer from sickness or disablement. The TILTLOCK® automatically locks when in the horizontal position and locks vertically as a support grab rail for standing patients. Fabricated with a chromed brass button release base housing, a solid brass concealed 4 fix wall "T" mount bracket and 304 stainless steel tube.

The TILTLOCK® SAFE-ASSIST® folding grab rail complies with clause 17 of AS 1428.1-2009 for Design and Construction.

Tested by ANTL, test report 2945.11.



GRAB RAILS SHOULD BE MOUNTED SO THAT THE TOP OF THE RAIL IS 800 mm TO 810 mm ABOVE THE FLOOR.

850 mm x 185 mm x 32 mm x dual bar folding grab rail with safety lock hinge mechanism. The TILTLOCK® automatically locks when in the horizontal position and locks vertically out of the way when not required. Fabricated with a chromed solid brass concealed wall mount with four fixing points and chromed brass button release housing with 304 stainless steel tube, giving a most pleasing finish.

M8 x 75, stainless steel hexagon coach screws and 10 mm wall plugs supplied with Tiltlock®

MUST BE FITTED TO A SOLID WALL OR OTHER FIRM SURFACE.

For special lengths, add or deduct \$5.00 per 100 mm.

PATENT NUMBER: 2006100929

	Code	Finish	GST Free	Features
<b>850 mm TILTLOCK® GRAB RAIL</b>				
<b>Please specify left or right hand</b>				
<p>Drawn left hand</p>	TL 850 LH SS	Satin Supreme™		850 mm x 185 mm x 32 mm dual bar folding grab rail fabricated from 304 stainless steel with safety lock hinge mechanism. The TILTLOCK® with quick release automatically locks when in horizontal position and locks vertically out of the way when not required.  <b>NO EXPOSED NUTS OR BOLTS</b> Stainless steel fixing screws supplied.
	TL 850 LH KG	Diamond Shur-Grip®		
	TL 850 LH WT	White		
	TL 850 RH SS	Satin Supreme™		
	TL 850 RH KG	Diamond Shur-Grip®		
	TL 850 RH WT	White		
<b>850 mm TILTLOCK® GRAB RAIL WITH FLEXIBLE ABS TOILET ROLL HOLDER</b>				
<p>Flexible fix toilet roll holder - TR 031 Drawn left hand</p>	TL 850T LH SS	Satin Supreme™		850 mm x 185 mm x 32 mm dual bar folding grab rail fabricated from 304 stainless steel with safety lock hinge mechanism. The TILTLOCK® with quick release automatically locks when in horizontal position and locks vertically out of the way when not required.  <b>Supplied with Flexible ABS toilet roll holder fastened to grab rail.</b>  <b>NO EXPOSED NUTS OR BOLTS</b> Stainless steel fixing screws supplied.
	TL 850T LH KG	Diamond Shur-Grip®		
	TL 850T LH WT	White		
	TL 850T RH SS	Satin Supreme™		
	TL 850T RH KG	Diamond Shur-Grip®		
	TL 850T RH WT	White		
<b>850 mm TILTLOCK® GRAB RAIL WITH SS FIXED TOILET ROLL HOLDER</b>				
<p>Drawn left hand</p>	TL 850S LH SS	Satin Supreme™		850 mm x 185 mm x 32 mm dual bar folding grab rail fabricated from 304 stainless steel with safety lock hinge mechanism. The TILTLOCK® with quick release automatically locks when in horizontal position and locks vertically out of the way when not required.  <b>Supplied with 19 mm stainless steel toilet roll holder secured to grab rail.</b>  <b>NO EXPOSED NUTS OR BOLTS</b> Stainless steel fixing screws supplied.
	TL 850S LH KG	Diamond Shur-Grip®		
	TL 850S LH WT	White		
	TL 850S RH SS	Satin Supreme™		
	TL 850S RH KG	Diamond Shur-Grip®		
	TL 850S RH WT	White		
<b>850 mm TILTLOCK® GRAB RAIL WITH NURSE CALL MOUNT BOX</b>				
<p>Drawn left hand</p>	TL 850N LH SS	Satin Supreme™		850 mm x 185 mm x 32 mm dual bar folding grab rail fabricated from 304 stainless steel with safety lock hinge mechanism. The TILTLOCK® with quick release automatically locks when in horizontal position and locks vertically out of the way when not required.  <b>Fitted with 304 stainless steel nurse call mount box. Nurse call switch not supplied with TILTLOCK®.</b>  <b>NO EXPOSED NUTS OR BOLTS</b> Stainless steel fixing screws supplied.
	TL 850N LH KG	Diamond Shur-Grip®		
	TL 850N LH WT	White		
	TL 850N RH SS	Satin Supreme™		
	TL 850N RH KG	Diamond Shur-Grip®		
	TL 850N RH WT	White		



# SWINGLOCK® AND SIDE ASSIST RAIL-WAYS®

SAFE-ASSIST® dual bar, side swing grab rail for parallel cisterns and water closet designs when the toilet is installed in a corner requiring a grab rail each side of the pan. The SWINGLOCK® Hexagon F&M Lift/drop locking system eliminates bar sway, locks 45 degrees left or right hand and locks 90 degrees parallel with the wall when not required.



Optional extra: TR 031 Toilet roll holder

The SWINGLOCK® grab rails are in compliance with the general requirements for applications in hospitals, homes for the elderly and nursing homes. For water closet where the SWINGLOCK® is not suitable we recommend the TILTLOCK®.

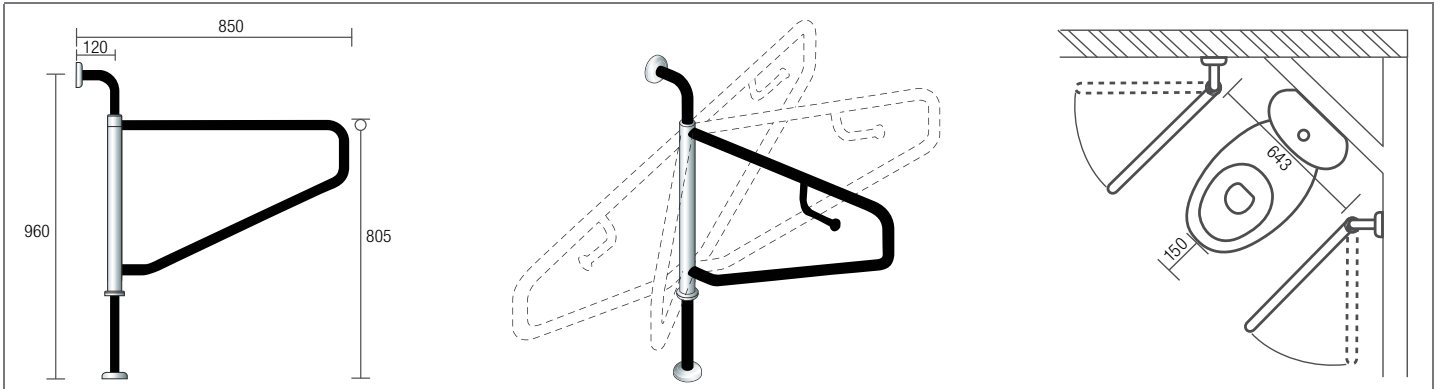

	Code	Finish	GST Free	Features	
<b>850 mm SWINGLOCK® SIDE ASSIST RAIL</b>					
	SL 850 SS	Satin Supreme™		850 mm x 805 mm dual bar SWINGLOCK® side swing grab rail. Fabricated from 304 stainless steel and assembled with 78 mm pre-formed domed CLAM FLANGE™. Stainless steel fixing screws supplied.	
	<b>WITH TOILET ROLL HOLDER</b>				
	SL 850 S SS	Satin Supreme™			
<b>WITH NURSE CALL HOOK</b>					
SL 850 NH SS	Satin Supreme™				
<b>850 mm x 800 mm x 450 mm TWIN ASSIST GRAB RAIL - SUITS EXPOSED &amp; CONCEALED CISTERNS</b>					
	CF 848 SS	Satin Supreme™		850 mm x 800 mm x 450 mm twin toilet assist grab rail with slide connecting bar to suit exposed and concealed cisterns. Fabricated from 304 stainless steel and assembled with 78 mm pre-formed domed CLAM FLANGE™. Stainless steel fixing screws supplied.	
<b>850 mm x 800 mm x 150 mm - GRAB RAIL WITH ROTATING SUPPORT LEG</b>					
	CF 882 SS	Satin Supreme™		850 mm x 805 mm free standing grab rail with rotating support leg. Fabricated from 304 stainless steel and assembled with 78 mm pre-formed domed CLAM FLANGE™. Stainless steel fixing screws supplied.	
	CF 882 PS	Polish Supreme™			
<b>850 mm x 800 mm - FREE STANDING GRAB RAIL</b>					
	CF 858 SS	Satin Supreme™		850 mm x 805 mm free standing grab rail. Fabricated from 304 stainless steel and assembled with 78 mm pre-formed domed CLAM FLANGE™. Stainless steel fixing screws supplied.	



# SAFE-ASSIST® FOLDING SHOWER SEATS

SAFE-ASSIST® folding shower seats for persons who suffer from sickness or disablement. Seat frames with tension grip hinge for horizontal and vertical movement are fabricated from 304 stainless steel and secured to the seat deck with concealed 316 stainless steel screws. Seat decks feature tamperproof, sanitary safe, Polar White, UV stabilised, High Density Polyethylene (HDPE) round edge with self draining channels.

SHOWER SEATS SHOULD BE MOUNTED SO THAT THE SEAT DECK IS 470 mm to 480 mm ABOVE THE FLOOR.



	Code	Finish	GST Free	Features
<b>SEAT SIZE - 960 mm x 400 mm - SHOWER SEAT COMPLIES WITH THE MINIMUM DESIGN, STRENGTH AND DIMENSION REQUIREMENTS OF AS 1428.1-2009</b>				
	SS 964 SS	Satin Supreme™		Seat size: 960 mm x 400 mm Grade 304 stainless steel frame with Polar White High Density Polyethylene (HDPE) seat deck with self draining channels. Complies with requirements of AS 1428.1-2009 for a 2 walled shower enclosure. Stainless steel fixing screws supplied. MAX. LOAD: 160 Kg (25 stone)
	SS 964 PS	Polish Supreme™		
<b>SEAT SIZE - 960 mm x 400 mm - SHOWER SEAT COMPLIES WITH THE MINIMUM DESIGN, STRENGTH AND DIMENSION REQUIREMENTS OF AS 1428.1-2009</b>				
	SS 964 WM	Satin Supreme™		<b>WHEELCHAIR TRANSFER SEAT.</b> Seat size: 960 mm x 400 mm seat supported by heavy duty Tension Grip hinge brackets. Most suitable for convenient transfer between wheelchair and shower seat. Assembled with Polar White, UV stabilised, fade resistant, High Density Polyethylene (HDPE) seat deck with self draining channels. Complies with requirements of AS 1428.1-2009 for a 2 walled shower enclosure. Stainless steel fixing screws supplied. MAX. LOAD: 160 Kg (25 stone) INSTALLATION HEIGHT OF SEAT: 470 mm - 480 mm
<b>SEAT SIZE - 960 mm x 400 mm - SHOWER SEAT COMPLIES WITH THE MINIMUM DESIGN, STRENGTH AND DIMENSION REQUIREMENTS OF AS 1428.1-2009</b>				
	SS 964 CW	Satin Supreme™		<b>DESIGNED FOR BATHROOMS WITH COVERED WALLS.</b> Seat size: 960 mm x 400 mm seat with 100 mm x 60 mm covered plated rear legs for fixing to floor with 10 mm front leg Acetyl plugs to suit shower cubical gradient. Assembled with Polar White, UV stabilised, fade resistant, High Density Polyethylene (HDPE) seat deck with self draining channels. Complies with requirements of AS 1428.1-2009 for a 2 walled shower enclosure. Stainless steel fixing screws supplied. MAX. LOAD: 160 Kg (25 stone)
<b>SEAT SIZE - 960 mm x 400 mm - SHOWER SEAT COMPLIES WITH THE MINIMUM DESIGN, STRENGTH AND DIMENSION REQUIREMENTS OF AS 1428.1-2009</b>				
	SS 964 MSS	Stainless Steel		Seat size: 960 mm x 400 mm Seat frame and 3 part slatted seat deck fabricated from 304 stainless steel. Powder coated totally white. Other colours available on request. Complies with requirements of AS 1428.1-2009 for a 2 walled shower enclosure. Stainless steel fixing screws supplied. MAX. LOAD: 160 Kg (25 stone)
	SS 964 MWT	White		

Suits all standard accessible suites

**WHEELCHAIR TRANSFER SEAT**  
Must be fitted to a solid wall or other firm surface.

Designed for covered walls - Floor mounted

Rounded stainless steel safety edge

### STANDARD FIXING - STUD WALLS

Use the 4 x stainless steel M8 x 75 mm coach screws supplied.  
 Fix seat with the coach screws into wall studs or nogging.  
 Shower seats must be fitted to a solid wall or into stud construction.  
 Wall surface must be flat.

Use the 4 x stainless steel M8 x 75 mm coach screws and plugs supplied.  
 Fix seat with wall plugs and coach screws onto wall.  
 The installer should ensure that the nature of the wall will provide a firm fixing for all screws supporting the shower seat.





# SAFE-ASSIST® PURPOSE BUILT SHOWER SEATS

SAFE-ASSIST® folding shower seats for persons who suffer from sickness or disablement. Seat frames with tension grip hinge for horizontal and vertical movement are fabricated from 304 stainless steel and secured to the seat deck with concealed 316 stainless steel screws. Seat decks feature tamperproof, sanitary safe, Polar White, UV stabilised, High Density Polyethylene (HDPE) round edge with self draining channels.

SHOWER SEATS SHOULD BE MOUNTED SO THAT THE SEAT DECK IS 470 mm to 480 mm ABOVE THE FLOOR.



	Code	Finish	Without GST	With GST	GST Free	Features	
<b>SEAT SIZE - 350 mm x 340 mm - FOR AREAS NOT STRICTLY DISABLED</b>							
	SS 220 WT	White				Seat size: 350 mm wide by 340 mm deep fold-away ABS white slatted shower seat with strong aluminium support struts and wall fixing bracket. Designed to be fitted to a solid wall or other firm surface inside a shower cubicle or over a bath. Has many usages.  Stainless steel fixing screws supplied.  MAX. LOAD: 115 Kg (18 stone)	
<b>SEAT SIZE - 600 mm x 400 mm - FOR AREAS NOT STRICTLY DISABLED</b>							
	SS 604 SS	Satin Supreme™				Seat size: 600 mm x 400 mm Grade 304 stainless steel frame with Polar White High Density Polyethylene (HDPE) seat deck with self draining channels.  Stainless steel fixing screws supplied.  MAX. LOAD: 160 Kg (25 stone)	
	SS 604 PS	Polish Supreme™					 Wall Bracket Dimension
	SS 604 MSS	Stainless Steel					
<b>SEAT SIZE - 800 mm x 450 mm - MEETS NEW ZEALAND STANDARDS NZS 4121:2001</b>							
	SS 845 SS	Satin Supreme™				Seat size: 800 mm x 450 mm Grade 304 stainless steel frame with Polar White High Density Polyethylene (HDPE) seat deck with self draining channels.  Stainless steel fixing screws supplied.  MAX. LOAD: 160 Kg (25 stone)	
							 Wall Bracket Dimension
<b>SEAT SIZE - 960 mm x 500 mm - BARIATRIC SEAT FOR AREAS NOT STRICTLY DISABLED</b>							
 <b>Bariatric seat - Designed for heavier loads</b>	SS 965 BS	Satin Supreme™				<b>LARGE SHOWER SEAT WITH ADDITIONAL CENTRE SUPPORT TO ACCEPT HEAVIER LOAD.</b>  Seat size: 960 mm x 500 mm wide BARIATRIC seat with centre legs so as to take more weight. Assembled with Polar White, UV stabilised, fade resistant, High Density Polyethylene (HDPE) seat deck with self draining channels.  Stainless steel fixing screws supplied.  MAX. LOAD: 200 Kg (32 stone)	
							 Wall Bracket Dimension
<b>SEAT SIZE - 600 mm x 450 mm - SHOWER SEAT FOR LIMITED WALL AREAS NOT STRICTLY DISABLED</b>							
 <b>Seat lifts side ways to wall</b> Patent Number: 2008100882	SS 645 SL	Satin Supreme™				<b>DESIGNED FOR OPPOSING WALL OPEN ENDED SHOWER ENCLOSURE AND SITUATIONS WHERE A WALL IS NOT WIDE ENOUGH TO ACCOMMODATE PRIOR ART FOLDABLE SEATS.</b>  Seat size: Side lift, 600 mm x 450 mm shower seat, assembled with Polar White, UV stabilised, fade resistant, High Density Polyethylene (HDPE) seat deck with self draining channels.  Stainless steel fixing screws supplied.  MAX. LOAD: 160 Kg (25 stone)	
							 Wall Bracket Dimension

### STANDARD FIXING - STUD WALLS

Use the 4 x stainless steel M8 x 75 mm coach screws supplied.  
 Fix seat with the coach screws into wall studs or nogging.  
 Shower seats must be fitted to a solid wall or into stud construction.  
 Wall surface must be flat.

### STANDARD FIXING - MASONRY WALLS

Use the 4 x stainless steel M8 x 75 mm coach screws and plugs supplied.  
 Fix seat with wall plugs and coach screws onto wall.  
 The installer should ensure that the nature of the wall will provide a firm fixing for all screws supporting the shower seat.





# Safe-Assist® BACKREST for Healthcare Applications

The BACKREST, a support device for toilets, bidets and the like, introduced into the Australian Standard for Access and Mobility to comply with the changing requirements for sanitary facilities.

The BACKREST provides a support that improves the comfort of using a toilet while simultaneously providing an acceptable level of safety for disabled, aged and infirmed.

Con-Serv® patented BACKREST options as shown are compatible with all cisterns. But due to the different dimensions in cistern design, it is essential to select the correct BACKREST option to comply with the Australian Access and Mobility Standard AS 1428.1-2009 for single (Figure 52 of AS 1428.1-

2009) or combined (Figure 50 of AS 1428.1-2009) sanitary compartments.

Tested by the Australian National Testing Laboratories Pty Ltd (ANTL) as outlined in clause 15.2.4 BACKREST of AS 1428.1-2009, careful selection from the Con-Serv® Safe-Assist® BACKREST range will ensure full compliance with the Australian Standards requirement. Floor mount BACKREST test report – 3104.11 and Wall Mount BACKREST test report – 3411.11

For further information, refer to the BACKREST Suitability Guide or contact our Technical Product Adviser on the Priority Phone Number – 1300 467 322.



## Safe-Assist® BACKREST Options



**Model - BR 395**  
PATENT NUMBER 2010100132

Suits all standard accessible suites. Ideally suited to applications when fastening to rear wall is not an option. E.g. vinyl walls or insufficient bracing.



**Model - BR 400**  
PATENT NUMBER 2010101409

Adjusts to suit cisterns from 340 mm to 476 mm width, while still allowing the unimpeded installation and access to other grab rails at side of pan as per requirements of AS 1428.1-2009 (fig 42).



**Model - BR 440**  
PATENT NUMBER 2010101409

Flexible installation left or right side of cisterns from 340 mm to 476 mm width and includes an additional 400 mm grab rail extension as per requirements of AS 1428.1-2009 (fig 42).

SUITABILITY GUIDE	BR 395	BR 400	BR 440
Sanitary Compartment with Conventional Pan	•	•	•
Sanitary Compartment with Wall Faced Pan		•	•
Sanitary Compartment with Shower and Conventional Pan	•	•	
Sanitary Compartment with Shower and Wall Faced Pan		•	



# SAFE-ASSIST® - BACKREST

SAFE-ASSIST® BACKREST support for single toilet suites and combined PWD sanitary compartments.

Robust designed 32 mm grade 304 stainless steel Backrest. Fabricated with a choice of 78 mm domed CLAM FLANGE™ or 50 mm HYGIENIC SEAL® healthsafe flange cover. The Backrest features a 96° tamperproof, sanitary safe, Polar White, UV stabilised High Density Polyethylene (HDPE) rounded edge back support.

AS 1428.1

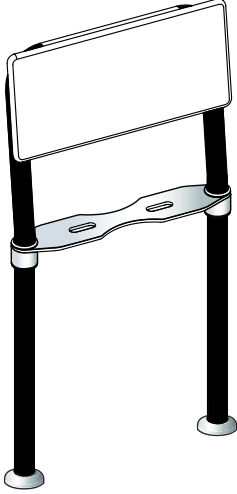
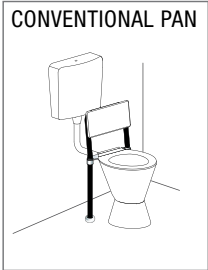
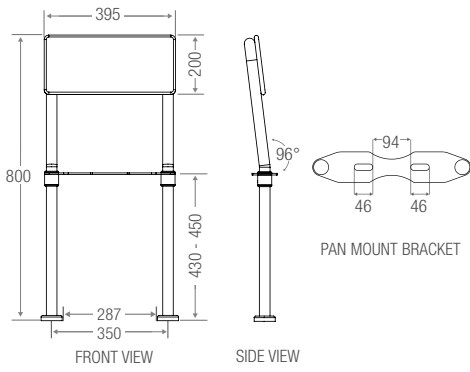
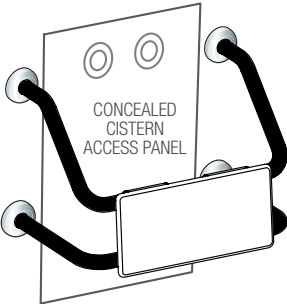
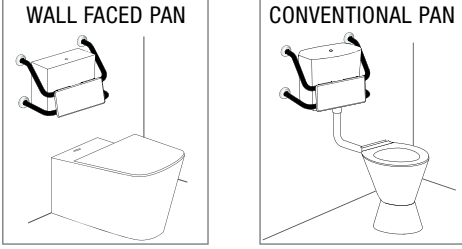
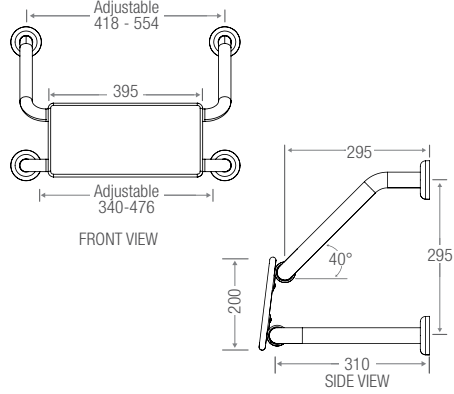
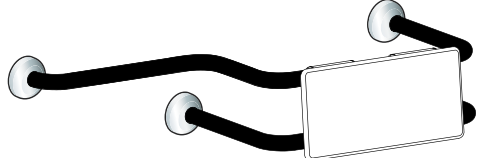
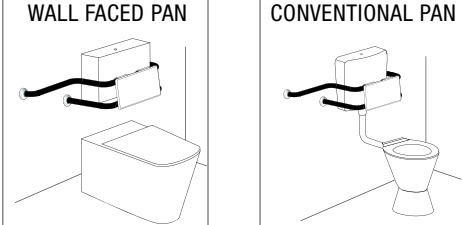
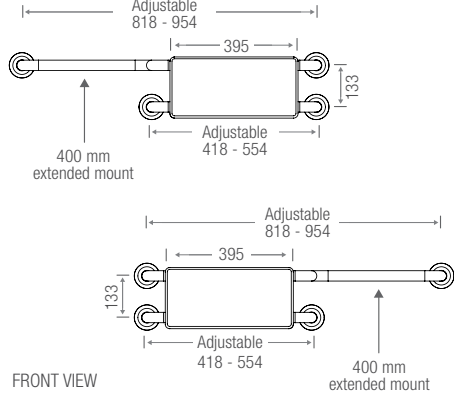

Complies as per the requirements of AS 1428.1-2009 section 15.2.4-BACKREST.

	Code	Finish	GST Free	Features
<b>BR 395 - FLOOR MOUNTED BACKREST</b>				
  Patent Number 2010100132	BR 395 SS	Satin Supreme™		<ul style="list-style-type: none"> <li>Suits all standard accessible suites. (Not wall faced pans)</li> <li>For single PWD cubicle with conventional pan.</li> <li>For combined PWD sanitary compartment with conventional pan and shower recess grabrail.</li> <li>Fixed to floor with triple screw floor mount and screw on sealed healthsafe flange covers.</li> <li>Stainless steel fixing screws supplied.</li> </ul>
	BR 395 PS	Polish Supreme™		
				
<b>BR 400 - WALL MOUNTED BACKREST</b>				
 Patent Number 2010101409	<b>CLAM FLANGE™</b>			<ul style="list-style-type: none"> <li>For single PWD cubicle with conventional pan.</li> <li>For single PWD cubicle with wall faced pan.</li> <li>For combined PWD sanitary compartment with conventional pan and shower recess grab rail.</li> <li>For combined PWD sanitary compartment with wall faced pan and shower recess grab rail.</li> <li>Also suitable for concealed cisterns.</li> <li>Stainless steel fixing screws supplied.</li> </ul>
	BR 400 CF SS	Satin Supreme™		
	BR 400 CF PS	Polish Supreme™		
 Patent Number 2010101409	<b>HYGIENIC SEAL®</b>			
	BR 400 HS SS	Satin Supreme™		
	BR 400 HS PS	Polish Supreme™		
				
<b>BR 440 - WALL MOUNTED BACKREST WITH 400 mm EXTENSION</b>				
 Patent Number 2010101409	<b>CLAM FLANGE™</b>			<ul style="list-style-type: none"> <li>For single PWD cubicle with conventional pan.</li> <li>For single PWD cubicle with wall faced pan.</li> <li>The adjustable 400 mm extended mount can be installed on the left or right hand side of cistern.</li> <li>Stainless steel fixing screws supplied.</li> </ul>
	BR 440 CF SS	Satin Supreme™		
	BR 440 CF PS	Polish Supreme™		
 Patent Number 2010101409	<b>HYGIENIC SEAL®</b>			
	BR 440 HS SS	Satin Supreme™		
	BR 440 HS PS	Polish Supreme™		
				



# Safe-Assist® ANTI-LIGATURE GRAB RAILS

## Bars for High Risk Applications

Specially designed 38 mm Anti-Ligature grab rails with barrier manufactured from grade 304 stainless steel for use in water closets and other assist requirement areas to eliminate the possibility of self harm by patients or inmates in psychiatric clinics, hospitals and detention facilities.

Generally meets the requirement of AS 1428.1-2009.



	Code	Finish	GST Free	Features
<b>VERTICAL ANTI-LIGATURE GRAB RAILS</b>				
	AL 1500 V SS	Satin Supreme™		<p>The anti-ligature barrier on the 38 mm vertical grab rail is a 2.5 mm grade 304 stainless steel plate which is centered 55 mm from back of rail to wall and continuously welded from flange to flange, giving improved access and grip ability on the grab rail.</p> <p>Manufactured with exposed flanges.</p> <p>Tamperproof stainless steel 14# x 1½" POST TORX screws supplied.</p> <p>SECTION VIEW</p>
	AL 900 V SS	Satin Supreme™		
	AL 600 V SS	Satin Supreme™		
	AL 450 V SS	Satin Supreme™		
<b>HORIZONTAL ANTI-LIGATURE GRAB RAILS</b>				
	AL 450 H SS	Satin Supreme™		<p>The anti-ligature barrier on the 38 mm horizontal grab rail is a 2.5 mm grade 304 stainless steel square section which is centered 74 mm from the underpart of the rail to wall and continuously welded from end to end giving a 55 mm access and grip ability on the grab rail.</p> <p>Tamperproof stainless steel 14# x 1½" POST TORX screws supplied.</p> <p>SECTION VIEW</p>
	AL 600 H SS	Satin Supreme™		
	AL 900 H SS	Satin Supreme™		
	AL 1500 H SS	Satin Supreme™		



# SAFE-ASSIST® ANTI-LIGATURE GRAB RAILS

Specially designed 38 mm toilet assist Anti-Ligature grab rails with combined vertical and horizontal barriers, manufactured from 304 stainless steel for use in water closets with concealed or exposed cisterns to eliminate the possibility of self harm by patients or inmates in psychiatric clinics, hospitals and detention facilities.

Generally meets the requirements of AS 1428.1-2009.



	Code	Finish	GST Free	Features
<b>90° ANTI-LIGATURE TOILET ASSIST GRAB RAILS</b>				
<b>Please specify left or right hand</b>				
<p>Drawn left hand</p> <p><b>For ambulant disabilities</b></p>	AL 454 LH SS	Satin Supreme™		450 mm x 450 mm LEFT HAND, 38 mm Anti-Ligature grade 304 stainless steel toilet assist grab rail with 30 mm combined underpart horizontal square section and 2.5 mm centered back plate both continuously welded to rail, giving a 55 mm access and grip ability on the grab rail.  Manufactured with exposed flanges.  Tamperproof stainless steel 14# x 1½" POST TORX screws supplied.
<b>90° ANTI-LIGATURE TOILET ASSIST GRAB RAILS</b>				
<b>Please specify left or right or centre fix</b>				
<p>Drawn right hand</p> <p><b>For ambulant disabilities</b></p>	AL 454 RH SS	Satin Supreme™		450 mm x 450 mm RIGHT HAND, 38 mm Anti-Ligature grade 304 stainless steel toilet assist grab rail with 30 mm combined underpart horizontal square section and 2.5 mm centered back plate both continuously welded to rail, giving a 55 mm access and grip ability on the grab rail.  Manufactured with exposed flanges.  Tamperproof stainless steel 14# x 1½" POST TORX screws supplied.
<b>90° ANTI-LIGATURE TOILET ASSIST GRAB RAILS</b>				
<b>Please specify left or right hand</b>				
<p>Drawn left hand</p>	AL 966 LH SS	Satin Supreme™		960 mm x 600 mm LEFT HAND, 38 mm Anti-Ligature grade 304 stainless steel toilet assist grab rail with 30 mm combined underpart horizontal square section and 2.5 mm centered back plate both continuously welded to rail, giving a 55 mm access and grip ability on the grab rail.  Manufactured with exposed flanges.  Tamperproof stainless steel 14# x 1½" POST TORX screws supplied.
<b>90° ANTI-LIGATURE TOILET ASSIST GRAB RAILS</b>				
<b>Please specify left or right hand</b>				
<p>Drawn right hand</p>	AL 966 RH SS	Satin Supreme™		960 mm x 600 mm RIGHT HAND, 38 mm Anti-Ligature grade 304 stainless steel toilet assist grab rail with 30 mm combined underpart horizontal square section and 2.5 mm centered back plate both continuously welded to rail, giving a 55 mm access and grip ability on the grab rail.  Manufactured with exposed flanges.  Tamperproof stainless steel 14# x 1½" POST TORX screws supplied.

**SPECIAL MAKE ANTI-LIGATURE GRAB RAILS CAN BE MANUFACTURED ON REQUEST TO SPECIFICATIONS  
NON RETURNABLE**



# About Stainless Steel Grab Rails

## Alloy Types

304 is the basic chromium-nickel austenitic stainless steel and has been found suitable for a wide range of applications. It is the most readily available in a variety of product forms. This grade is easy to form and fabricate and is resistant to corrosion.

304L is the low carbon version of 304. The use of the letter "L" after the grade number means that the carbon content is restricted to a maximum of 0.03% (normal levels are 0.08%). The lower level of carbon is usually used where welding is performed and helps to prevent the chromium from being depleted so it can form the "passive" oxide layer, giving excellent resistance to corrosion and metallurgically incapable of rusting.

316 offers more corrosion-resistance through the addition of molybdenum, this grade is desirable where the possibility of severe corrosion exists, such as marine environments.

316L is the low carbon version of 316.

## What Does 18/8 Mean

The first number is the amount of chromium that is contained in the stainless. The second number is the amount of nickel. So 18/8 means that this stainless steel contains 18% chromium and 8% nickel and is part of the grade family "300 series" stainless which is non-magnetic.

## Care of Stainless Steel

To have optimum corrosion resistant stainless steel, surfaces must be clean and have an adequate supply of oxygen to maintain their 'passive' surface layer. Passive Film is invisible in stainless steel. It's created when oxygen combines with chromium in the stainless to form chromium oxide.

Stainless steel supplied by reputable manufacturers or fabricators will normally be clean and contamination free.



Generally, stubborn stains and discolouration corrosion occurs when there is an overall breakdown of the 'passive' film, due to incorrect cleaning procedures. Rust staining can occur as anything from a slight brown 'bloom' on the surface to severe surface pitting or rusty scour marks on items such as GRAB RAILS and HAND RAILS. Cleanliness and stainless steel are closely related in many applications and each is dependent upon the other. Cleanliness is essential for maximum resistance to corrosion.

## The Cleaning of Stainless Steel

Alkali cleaners such as baking soda or ammonia are effective to clean stainless steel. Always attempt the mildest cleaning method first. Stainless steel's best friends are quite simply soap, mild detergent or ammonia solution in warm water applied with a soft cloth or nylon sponge for polished finishes followed by a clean water rinse. Dry wipe eliminates the possibility of water stains. Occasionally, the use of the least coarse nylon scouring pad may be required for satin finishes.

## What to Avoid

Do not use ordinary steel wool. Iron particles can become embedded in stainless steel and cause 'iron' contamination.

Do not use chlorides or acids as they are reactive to stainless steel. Strong acid solutions like hydrochloric acid or "spirit of salts" are sometimes used to clean masonry and tiling of new bathrooms and toilets, but they should NEVER be permitted to come into contact with metals, INCLUDING STAINLESS STEEL.

Halogen salts, especially chlorides easily penetrate the "passive film" of stainless steel and will allow corrosive attack to occur. The halogens are easy to recognize because they end in the letters "INE". Listed in order of their activity are:

- Fluorine
- Chlorine
- Bromine
- Iodine
- Astatine

Never use brick cleaning liquids which contain hydrochloric acid. Many cleaning solutions and solvents contain chlorinated hydrocarbons. If a cleaner containing chlorides, bleaches and hypochlorites are used, it must be promptly and thoroughly cleaned off.

Please note: The Con-Serv warranty on grab rails will be null and void should they be exposed to chemical corrosion due to incompetent cleaning practices.





Codes A to Z	Page	Description	Flow Control ATS 5200.037.2	6 Star Less than 4.5	5 Star > 4.5 but <= 6.0	3 Star > 7.5 but <= 9.0	2 Star > 9.0 but <= 12
AF 2 FVS	41	Aerator stream spray		•	•		
AF 5 FVB	40	Aerator bubble spray	•		•		
AF 5 TMB	40	Aerator bubble spray			•		
AF 5 VFS	41	Aerator stream spray			•		
AF 8 TMB	40	Aerator bubble spray				•	
AF 8 FVB	40	Aerator bubble spray	•			•	
AF 15 DFB	40	Aerator bubble spray			•	•	
AF 15 DMB	40	Aerator bubble spray			•	•	
AF 20	41	Swivel aerator					
AF 22 DFB	40	Aerator bubble spray	•		•	•	
AF 22 DFS	41	Aerator stream spray		•	•		
AF 24 DMB	40	Aerator bubble spray	•		•	•	
AF 24 DMS	41	Aerator stream spray		•	•		
AF 22 F	41	Aerator flow adaptor	•	•	•	•	•
AF 22 VFB	40	Aerator bubble spray	•		•	•	
AF 22 VFS	41	Aerator stream spray		•	•		
AF 24 M	41	Aerator flow adaptor	•	•	•	•	•
AF 24 VMB	40	Aerator bubble spray	•		•	•	
AF 24 VMS	41	Aerator stream spray		•	•		
AF 019	42	Flow control disc					
AF 048	42	Whisper wash® - F&M	•				
AF 053	42	Basin flow valve - M&F	•	•	•	•	•
AF 054	42	Flow valve - F&M	•	•	•	•	•
AF 055	42	Flange flow valve - F&M	•	•	•	•	•
AF 059	42	Hose tap valve - M&F	•				
AF 071	45	Toilet Cistern Water Flush Regulator	•				
AF 086	42	Flow interchange spigot					

Codes A to Z	Page	Description
AL 450 H	86	450 mm horizontal anti-ligature grab rail
AL 450 V	86	450 mm vertical anti-ligature grab rail
AL 454 LH	87	90° anti-ligature toilet assist grab rail
AL 454 RH	87	90° anti-ligature toilet assist grab rail

Codes A to Z	Page	Description
AL 600 H	86	600 mm horizontal anti-ligature grab rail
AL 600 V	86	600 mm vertical anti-ligature grab rail
AL 900 H	86	900 mm horizontal anti-ligature grab rail
AL 900 V	86	900 mm vertical anti-ligature grab rail

Codes A to Z	Page	Description
AL 966 LH	87	90° anti-ligature toilet assist grab rail
AL 966 RH	87	90° anti-ligature toilet assist grab rail
AL 1500 H	86	1500 mm horizontal anti-ligature grab rail
AL 1500 V	86	1500 mm vertical anti-ligature grab rail
BA 100	2	Tumbler holder
BA 101	2	Soap dish holder
BA 104	2	Towel rail single 600 mm
BA 105	2	Towel rail single 750 mm
BA 106	2	Towel rail double 600 mm
BA 107	2	Towel rail double 750 mm
BA 108	3	Frosted tempered glass shelf
BA 111	3	Hand towel rail
BA 112	3	Paper holder
BA 114	3	Toilet brush with holder
BA 115	3	Single hook
BA 219	7	Foot rest
BA 700	4	Tumbler holder
BA 700 GO	4	Tumbler glass only
BA 701	4	Soap dish
BA 703	4	Towel ring
BA 704	4	Towel rail 600 mm
BA 705	4	Towel rail 800 mm
BA 706	4	Towel rail double 600 mm
BA 707	5	Towel rail double 800 mm

Codes A to Z	Page	Description
BA 708	5	Stainless steel 500 mm shelf
BA 710	5	Stainless steel 350 mm shelf
BA 712	5	Paper holder
BA 714	5	Toilet brush holder
BA 714 BH	5	Handle only
BA 714 BO	5	Toilet brush only
BA 714 GO	5	Toilet brush glass only
BA 715	6	Double robe hook
BA 718	6	Stainless steel corner shelf
BA 721	6	Spare paper holder
BA 729	6	Vanity shelf with barrier 10 mm
BA 729 BO	3	Glass shelf, barrier only
BA 739	6	Corner shelf with barrier 10 mm
BA 739 BO	6	Corner shelf, barrier only
BA 742	7	Wall mounted soap dispenser
BA 742 DP	7	Dispenser pump
BA 750	7	Wall mounted toilet brush holder
BA 751	7	Toilet brush holder
BA 769	6	Mount brackets for glass shelf
BA 780	7	Dual sided mirror
BA 782	7	Clothes line
BR 395	85	Floor Mounted Backrest
BR 400	85	Wall Mounted Backrest
BR 440	85	Wall Mounted Backrest with 400 mm extension



**WaterMark**  
AS/NZS 2845.1  
WMKA 02696



**WaterMark**  
ATS 5200.012  
WMKA 21148



**WaterMark**  
AS 5200.037.2  
WMKA 00667



4.5  
Litres per minute



6  
Litres per minute



9  
Litres per minute



12  
Litres per minute

Codes A to Z	Page	Description	Dual Check AS/NZS 2845.1	Stop Cock ATS 5200.012	Flow Control ATS 5200.037.2	6 Star Less than 4.5	5 Star > 4.5 but <= 6.0	3 Star 7.5 but <= 9.0	2 Star > 9.0 but <= 12.0
BV 100	43	Whisper flow®		•	•	•	•	•	•
BV 105	43	Whisper check	•	•	•	•	•	•	•
BV 110	43	Whisper wash® MK2		•					
BV 115	43	Isolating ball valve	•	•					

Codes A to Z	Page	Description
CF 041	71	Clam flange 400 x 1100 mm shower recess grab rail
CF 045	68	Clam flange 450 x 500 mm ambulant grab rail
CF 046	69	Clam flange 400 x 600 mm ambulant grab rail
CF 071	71	Clam flange 700 x 1100 mm shower recess grab rail
CF 077	68	Clam flange 700 x 700 mm toilet assist grab rail
CF 106	69	Clam flange 1030 x 600 mm toilet assist grab rail
CF 116	69	Clam flange 1110 x 1030 x 600 mm toilet assist grab rail
CF 191	71	Clam flange 1170 x 1100 mm inverted "T" grab rail
CF 197	68	Clam flange 1010 x 1010 x 700 mm toilet assist grab rail
CF 300	66	Clam flange 300 mm straight grab rail
CF 400	66	Clam flange 400 mm straight grab rail
CF 450	66	Clam flange 450 mm straight grab rail
CF 454	69	Clam flange 450 x 450 mm ambulant grab rail
CF 457	68	Clam flange 450 x 700 mm toilet assist grab rail
CF 500	66	Clam flange 500 mm straight grab rail
CF 600	66	Clam flange 600 mm straight grab rail
CF 606	69	Clam flange 600 x 600 mm toilet assist grab rail
CF 606	69	Clam flange 600 x 600 mm toilet assist grab rail
CF 660	70	Clam flange 600 x 600 mm corner grab rail
CF 700	66	Clam flange 700 mm straight grab rail
CF 711	71	Clam flange 760 x 1000 x 1100 mm shower grab rail
CF 750	67	Clam flange 750 mm straight grab rail

Codes A to Z	Page	Description
CF 757	70	Clam flange 750 x 750 mm corner grab rail
CF 761	70	Clam flange 760 x 1000 mm corner grab rail
CF 770	70	Clam flange 700 x 700 mm corner grab rail
CF 800	67	Clam flange 800 mm straight grab rail
CF 848	81	Clam flange 850 x 800 x 450 mm twin assist grab rail
CF 858	81	Clam flange 850 x 805 mm free standing grab rail
CF 877	68	Clam flange 870 x 700 mm toilet assist grab rail
CF 880	70	Clam flange 800 x 800 mm corner grab rail
CF 882	81	Clam flange 850 x 805 x 150 mm assist grab rail
CF 900	67	Clam flange 900 mm straight grab rail
CF 947	68	Clam flange 940 x 700 mm toilet assist grab rail
CF 966	69	Clam flange 960 x 600 mm toilet assist grab rail
CF 1000	67	Clam flange 1000 mm straight grab rail
CF 1100	67	Clam flange 1100 mm straight grab rail
CF 1200	67	Clam flange 1200 mm straight grab rail
CR 022	9	25 mm bath towel shelf
CR 036	9	25 mm ramped rail with soap basket
CR 300	9	25 x 300 mm straight rail
CR 450	9	25 x 450 mm straight rail
CR 600	9	25 x 600 mm straight rail
CR 900	9	25 x 900 mm straight rail
CR 1200	9	25 x 1200 mm straight rail



Codes A to Z	Page	Description	Dual Check AS/NZS 2845.1	Showers AS /NZS 3662	3 Star > 6.0 but <= 7.5	3 Star > 7.5 but <= 9.0	2 Star > 9.0 but <= 12.0
CS 007	18	Cobra - tamper proof		•	•	•	
CS 008	18	Pioneer - tamper proof		•	•	•	•
CS 009	18	Vanguard - tamper proof		•		•	
CS 051	18	Eclipse - tamper proof		•		•	•
CS 061	18	Zodiac - tamper proof - 55 mm arm		•		•	
CS 071	18	Zodiac - tamper proof - 100 mm arm		•			•



Codes A to Z	Page	Description	Dual Check AS/NZS 2845.1	Showers AS /NZS 3662	3 Star > 7.5 but <= 9.0	2 Star > 9.0 but <= 12
DC 042	43	Dual check ½" - M&F	•			
DC 043	43	Dual check ½" - F&M	•			
DC 057	43	Dual check - M&M	•			
DV 021	37	Switchcock valve				
DV 044	45	On/off control valve				
DV 067	37	Hob mount long-reach bath diverter				
DV 068	37	Long-reach bath diverter		optional		
DV 069	37	Extended long-reach bath diverter		optional		
DV 070	37	Diverter hob base upstand				
EB 045	35	Wall outlet elbow with dual check valve	•			
EB 046	35	Wall outlet elbow with dual check valve	•			
EB 073	35	Wall outlet bracket with dual check valve		•		
EB 074	35	Wall mount handset bracket				
EB 075	35	Square-edge wall outlet elbow		•		
EB 076	35	Square-edge wall outlet bracket		•		
EB 085	35	Wall mount ABS handset bracket				
FM 070	45	Basin flow cup				
FM 075	45	Shower flow mug				
FS 038	42	Flood stop valve				
GB 071 C, F, P	60	Premium Hosfab - 700 x 1100 mm	•	•	•	•
GB 711 C, F, P	61	Premium Hosfab - 760 x 1000 x 1100 mm	•	•	•	•
GB 900 C, F, P	59	Premium Hosfab - 900 mm	•	•	•	•
GS 071 C, F, P	56	Standard Hosfab - 700 x 1100 mm	•	•	•	•
GS 191 C, F, P	57	Standard Hosfab - 1170 x 1100 mm	•	•	•	•
GS 900 C, F, P	55	Standard Hosfab - 900 mm	•	•	•	•

Codes A to Z	Page	Description
HC 010	45	Brass friction slide handpiece cradle
HC 020	45	Brass slide rail handpiece cradle
HC 024	62	Grab rail glide slide handset cradle
HC 025	45	ABS slide rail handpiece cradle
HM 019	27	Hob mount
HP 025	34	Klipper - on/off lever function

Codes A to Z	Page	Description
HP 028	34	Heritage - all brass handpiece with full pattern spray
HP 031	34	Champagne - pulsator massager
HP 034	34	Princess - full pattern spray
HP 036	34	Hosfab - full pattern spray
HP 037	19	Breeze - pulsator massager
HP 038	34	Streamjet™



Codes A to Z	Page	Description	Dual Check AS/NZS 2845.1	Showers AS /NZS 3662	3 Star > 7.5 but <= 9.0	2 Star > 9.0 but <= 12.0
HP 038	19	Streamjet™ - traditional				
HP 039	34	Slender - turbo pulsator massager				
HP 041	34	Quewb - square shape design				
HP 042	19	Streamjet™ - turbo pulsator				
HP 049	62	Colt wash down gun				
HP 130	19	Streamjet™ - XL				
HS 010 C, Z, J, P, T, X	20	Handheld showers - crystal brass rail	•	•	•	•
HS 010 Q	30	Handheld showers - quewb brass rail	•	•	•	•
HS 011 C, Z, J, P, T, X	21	Handheld showers - wall outlet bracket	•	•	•	•
HS 011 Q	30	Handheld showers - wall outlet bracket	•	•	•	•
HS 013 C, Z, J, P, T, X	22	Handheld showers - for low water outlets	•	•	•	•
HS 014 C, Z, F, P	23	Handheld showers - comfort brass rail	•	•	•	•
HS 017 C, Z, J, P, T, X	24	Handheld showers - shower kits for slide rails	•	•	•	•
HS 018 KIT 1-7	51	Commercial Hosfab - options	•	•	•	•
HS 018 KIT 9-14	52	Commercial Hosfab - options	•	•	•	•
HS 018 KIT 16-22	53	Commercial Hosfab - options	•	•	•	•
HS 019 C, Z, J, P, T, X	25	Handheld showers - wall mount-diverter	•	•	•	•
HS 020 C, Z, J, P, T, X	26	Handheld showers - polar brass slide rail	•	•	•	•
HS 021 C, P, J, K	27	Handheld showers - hob mount basin sets	•	•	•	•
HS 032 BE	63	Hygienic seal blank end flange				

Codes A to Z	Page	Description
HS 032 FC	63	Hygienic seal flange cover
HS 032 MP	63	Hygienic seal wall mount plate
HS 041	77	Hygienic seal 400 x 1100 mm shower grab rail
HS 045	74	Hygienic seal 450 x 450 mm ambulant grab rail
HS 046	75	Hygienic seal 400 x 600 mm toilet assist grab rail
HS 071	77	Hygienic seal 700 x 1100 mm shower grab rail
HS 077	74	Hygienic seal 700 x 700 mm toilet assist grab rail
HS 106	75	Hygienic seal 1030 x 600 mm toilet assist grab rail
HS 109	78	Hygienic seal 1000 x 19 mm grab rail with towel rail
HS 116	75	Hygienic seal 1110 x 1030 x 600 mm toilet assist grab rail
HS 129	78	Hygienic seal 1200 x 19 mm grab rail with towel rail

Codes A to Z	Page	Description
HS 191	77	Hygienic seal 1170 x 1100 mm inverted "T" grab rail
HS 197	74	Hygienic seal 1110 x 940 x 700 mm toilet assist grab rail
HS 200	72	Hygienic seal 200 mm straight grab rail
HS 300	72	Hygienic seal 300 mm straight grab rail
HS 400	72	Hygienic seal 400 mm straight grab rail
HS 450	72	Hygienic seal 450 mm straight grab rail
HS 454	75	Hygienic seal 450 x 450 mm ambulant grab rail
HS 457	74	Hygienic seal 450 x 700 mm ambulant grab rail
HS 500	72	Hygienic seal 500 mm straight grab rail
HS 600	72	Hygienic seal 600 mm straight grab rail
HS 606	75	Hygienic seal 600 x 600 mm toilet assist grab rail



Codes A to Z	Page	Description
HS 619	78	Hygienic seal 600 x 19 mm grab rail with towel rail
HS 660	76	Hygienic seal 600 x 600 mm corner grab rail
HS 700	72	Hygienic seal 700 mm straight grab rail
HS 711	77	Hygienic seal 760 x 1000 x 1100 mm shower grab rail
HS 750	73	Hygienic seal 750 mm straight grab rail
HS 757	76	Hygienic seal 750 x 750 mm corner grab rail
HS 761	76	Hygienic seal 760 x 1000 mm corner grab rail
HS 770	76	Hygienic seal 700 x 700 mm corner grab rail
HS 800	73	Hygienic seal 800 mm straight grab rail

Codes A to Z	Page	Description
HS 819	78	Hygienic seal 800 x 19 mm grab rail with towel rail
HS 877	74	Hygienic seal 870 x 700 mm toilet assist grab rail
HS 880	76	Hygienic seal 800 x 800 mm corner grab rail
HS 900	73	Hygienic seal 900 mm straight grab rail
HS 966	75	Hygienic seal 940 x 600 mm toilet assist grab rail
HS 947	74	Hygienic seal 970 x 700 mm toilet assist grab rail
HS 1000	73	Hygienic seal 1000 mm straight grab rail
HS 1100	73	Hygienic seal 1100 mm straight grab rail
HS 1200	73	Hygienic seal 1200 mm straight grab rail



Codes A to Z	Page	Description	Flow Control ATS 5200.037.2	Dual Check AS/NZS 2845.1	Showers AS /NZS 3662	3 Star > 7.5 but <= 9.0	2 Star > 9.0 but <= 12.0
ID 018 - 3	49	Independent Hosfab - 1000 mm		•	•	•	•
ID 018 - 20	49	Independent Hosfab - 700 x 1000 mm		•	•	•	•
ID 018 - 21	49	Independent Hosfab - 1170 x 1100 mm		•	•	•	•
LF 900	79	900 mm linear grab rail/shower kit					
LR 200	79	200 mm linear grab rail					
LR 300	79	300 mm linear grab rail					
LR 450	79	450 mm linear grab rail					
LR 454	79	450 x 450 mm ambulant toilet assist grab rail					
LR 600	79	600 mm linear grab rail					
LR 877	79	870 x 700 mm toilet assist linear grab rail					
LR 900	79	900 mm linear grab rail					
LR 966	79	960 x 600 mm toilet assist grab rail					
MB 043 FP	44	Spindle flush plug					
MB 043 IK	44	Meter-Beater® installation kit					
MB 043 RT	44	Meter-Beater® - reamer tool					
MB 043 TT	44	Meter-Beater® - tapping tool					
MB 045	44	Meter-Beater® 5 & 6 star	•			•	•
MB 045 JV	44	Meter-Beater® jumper valve					



Codes A to Z	Page	Description	Flow Control ATS 5200.037.2	Showers AS /NZS 3662	3 Star > 6.0 but <= 7.5	3 Star > 7.5 but <= 9.0	2 Star > 9.0 but <= 12.0
MB 045 OR	44	Meter-Beater® "O" ring seal					
MB 047	44	Meter-Beater® - ceramic 5 & 6 star	•			•	•
OH 001	10	Breeze Pulsator		•		•	•
OH 003	11	Eclipse		•		•	•
OH 005	12	Paddington		•		•	•
OH 006	14	Streamjet®		•		•	•
OH 007	13	Grenada		•	•	•	•
OH 008	15	Streamjet® XL		•		•	•
OH 028	16	Cosmic		•		•	•
OH 030	17	Quewb		•		•	•

Codes A to Z	Page	Description
PM 932	62	Push-Pullme® showerhead positioning rod
QR 027	33	Quick release hose coupling
SA 005	38	55 mm fixed arm
SA 030	38	150 mm upswept fixed arm
SA 060	38	300 mm Clicklock™ adjustable/orbital arm
SA 070	38	240 mm adjustable arm
SA 090	38	290 mm swan neck
SA 100	38	100 mm fixed arm
SA 140	39	140 mm swivel crane neck arm
SA 165	38	165 mm grand style arm
SA 200	39	200 mm vertical arm
SA 310	39	310 mm horizontal arm
SA 345	39	345 mm swivel swan neck arm
SA 350	39	350 mm vertical arm
SA 380	39	380 mm swivel crane neck arm
SD 025	45	ABS 25 mm soap dish
SD 032	62	Grab rail soap dish holder
SH 012	32	1200 mm shower hose
SH 015	32	1500 mm shower hose

Codes A to Z	Page	Description
SH 015 TW	36	1500 mm shower hose
SH 020	32	1500 mm shower hose
SH 027	33	Hose repair parts
SH 030	32	3000 mm shower hose
SH 035	32	3500 mm shower hose
SH 040	32	4000 mm shower hose
SH 900	32	900 mm shower hose
SL 850	81	Clam flange 850 x 805 mm side swing grab rail
SL 850 NH	81	Clam flange 850 x 805 mm side swing grab rail with nurse call hook
SL 850 S	81	Clam flange 850 x 805 mm side swing grab rail with toilet roll holder
SP 063	38	Adjustable arm olive, spare part
SR 010	36	Crystal slide rail
SR 020	36	Polar slide rail
SR 025	36	Twin waters slide rail
SR 026	36	Riviera slide rail
SR 028	36	Quewb slide rail
SR 029	36	Crane neck twin waters slide rail
SR 685	62	Friction slide track cradle & collars
SS 220	83	350 x 340 mm folding slatted shower seat

Codes A to Z	Page	Description
SS 604	83	600 x 400 mm folding shower seat
SS 645	83	600 x 450 mm folding shower seat
SS 845	83	800 x 450 mm folding shower seat
SS 964 CW	82	960 X 400 mm folding shower seat for coved walls
SS 964 SS	82	960 x 400 mm folding shower seat
SS 964 MSS	82	960 x 400 mm stainless steel slatted folding shower seat
SS 964 WM	82	960 x 400 mm wheelchair transfer seat
SS 964 MWT	82	960 x 400 mm white slatted folding shower seat

Codes A to Z	Page	Description
SS 965	83	960 x 500 mm bariatric folding shower seat
TL 850	80	Tiltlock® lock up lock down grab rail
TL 850 N	80	Tiltlock® lock up lock down grab rail with nurse call
TL 850 S	80	Tiltlock® with stainless steel toilet roll holder
TL 850 T	80	Tiltlock® with ABS toilet roll holder
TL 850 US	63	Tiltlock® floor mount upstand
TL 850 WC	63	Tiltlock® (TPE) wall mount cover
TL 850 WM	63	Tiltlock® wall mount bracket

Codes A to Z	Page	Description
TR 031	62	Grab rail flexible fix toilet roll holder
TW 025 PC, PH, PP, PZ	28	Handheld showers - paddington twin waters
TW 025 CC, CZ, CJ, CP, CT, CX	29	Handheld showers - cosmic twin waters
TW 029 CC, CZ, CJ, CP, CT, CX	31	Handheld showers - cosmic twin waters
TW 029 Q	30	Handheld showers - quewb twin waters



Dual Check AS/NZS 2845.1	Showers AS /NZS 3662	3 Star > 7.5 but <= 9.0	2 Star > 9.0 but <= 12.0
•	•	•	•
•	•	•	•
•	•	•	•
•	•	•	•

Codes A to Z	Page	Description
WB 001	8	Wire basket - rectangular - large
WB 002	8	Wire basket - rectangular - medium
WB 003	8	Wire basket - rectangular - small
WB 004	8	Wire basket - open front rectangular - medium
WB 005	8	Wire basket - open front rectangular - small
WB 006	8	Wire basket - corner basket with hook
WB 007	8	Wire basket - corner basket - large
WB 008	8	Wire basket - corner basket - medium
WB 009	8	Wire basket - corner basket - small
WB 010	8	Wire basket - semi circular basket - large
WF 057	39	Flange - domed & square

## COLOUR SELECTION CHART

Other colours are available on request. To select another colour refer to the Dulux powder coatings colour selector at [www.duluxpowders.com.au](http://www.duluxpowders.com.au).

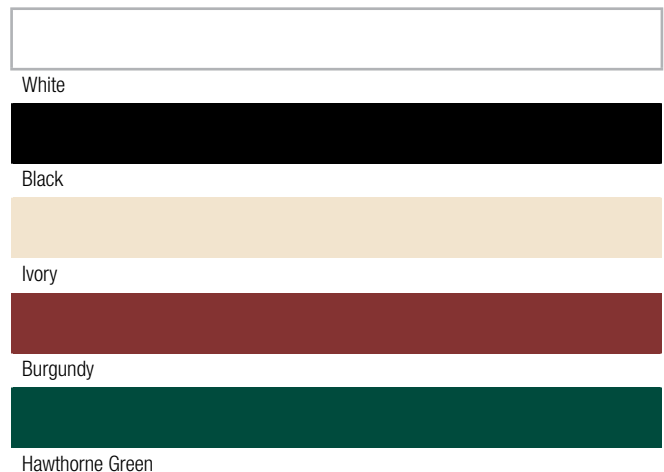

Disclaimer: The colours shown above are only approximations of the actual colours used when the products are coated.

1. Dispatch of goods will be as soon as practicable, having regard to all orders on hand to the arrangements of the company's distribution programme. Orders including for local delivery are only accepted subject to the company's ability to supply and on the condition that the goods will be accepted at prices ruling on the dates of dispatch. No responsibility will be accepted for customers pricing information being out of date.
2. No binding contract, shall exist until the buyer's order has been accepted in writing. In the event of there being any conflict between these conditions of sale and any conditions of purchase, or any other terms, conditions or warranties stipulated by the buyer, the company's conditions shall prevail unless otherwise agreed in writing.
3. Quotations given and orders accepted are based on the current cost of distribution and are subject to amendment on or after acceptance to meet any recognised rise or fall in such cost. Any alterations in quality or delivery may necessitate an adjustment of prices. No order may be suspended, cancelled or amended without the company's agreement in writing and the buyer shall agree to accept liability for purchase, stock, work in progress, labour costs or unrecovered overheads, etc., consequent upon the suspension, cancellation or amendment of any order agreed to by the company.
4. Any times quoted for delivery are estimates only and the company shall not be liable for failure to deliver or for delivery arising from any cause whatsoever beyond the company's control. The buyer shall not be relieved of any obligation to accept or pay for goods by reason of delay in delivery or dispatch. The company reserves the right to deliver by instalment, and each instalment shall be deemed to be sold under a separate contract. Failure to deliver any instalment shall not entitle the buyer to repudiate the contract.
5. Unless otherwise expressly agreed by, or shown on an invoice issued by Con-Serv, the prices specified include GST. The customer must bear and pay all GST or any other tax or duty that may be imposed on or in relation to any supply.
6. Stock will not be accepted for return unless prior arrangements have been made. The returned goods and packaging must be undamaged and in original condition. A restocking fee of 15% of the net invoice value will apply to all stock returns, unless special arrangements have been made prior to the return of the goods. "Freight collect" charges for returned goods will be deducted from credit notes issued, unless we agree in advance to accept such charges.
7. No conditions or warranties expressed or implied by law, and no representations or statements are binding on the company unless set out in this contract.
8. Payment for goods dispatched strictly 30 days from the closing date of each month. Under Retention of Title, ownership of all goods, shall remain with the company until all outstanding monies owed by the buyer have been paid. If the buyer makes default in any payment or commits an act of bankruptcy, or being a body corporate, goes or is put into liquidation (other than a voluntary liquidation for the purpose of amalgamation or reconstruction), the company may at its option withhold further deliveries or cancel the contract without prejudice to any rights to recover any debt of damages. The company shall be at liberty at its discretion to charge interest on all overdue accounts. Credit is extended only to regular customers with appropriate credit ratings. Payment is expected strictly "30 days from date of invoice". Deductions from or alterations to invoices and/or statement will not be accepted.
9. Unless otherwise advised, the company will apply a freight charge for store purchases under \$150.00 GST inclusive.
10. Off-loading shall be the entire responsibility of the buyer and the buyer shall be responsible for providing labour and facilities at the delivery points for unloading goods ordered by him and keep the company indemnified from the against all claims whatsoever arising from such unloading conditions.
11. The buyer shall inspect the goods as soon as possible after delivery. No claim by the buyer need to be recognised unless made in writing within 10 days after delivery of the goods to the buyer, quoting original invoice number and date. No claim for damage or resultant expenses direct or indirect of any goods shall in any case exceed the invoice value of the goods in respect of which damage or expense shall arise. All damage or expenses over and above such invoiced value shall be the responsibility of the buyer. Goods are not to be returned under any circumstances before instructions for their return or disposal are issued by Con-Serv Corporation Australia Pty. Ltd. Failure to observe this condition may invalidate any insurance claims, and the resulting losses are for the account of the customer.
12. Any description of goods contained in this contract is given by way of identification only, and use of such description shall not constitute this contract a sale description.
13. All tools gauges, jigs, drawings, blue prints, specifications, check fixtures, screens, photographs, negative and positive films, stencils and similar items which are manufactured, paid for, supplied or used by the company in connection with any order or enquiry shall remain the property of the company and shall not be produced without the company's written permission, and the company reserves the right to sell to other buyers any products made using the items referred to above.
14. The buyer shall not without the consent in writing of the company assign or transfer the contract or any part of it or any part of it to a third party except as part of a company amalgamation or reconstruction.
15. Any disputes on the contract are to be submitted to arbitration in the state in which the goods are distributed.
16. In addition to any line to which the company may be statute or otherwise be entitled, the company shall, in the event of the buyers insolvency, bankruptcy or winding up, be entitled to a general lien on all property or goods belonging to the buyer in the company's possession, (although such goods or some of them have been paid for), for the unpaid price of any other goods sold and delivered to the buyer under this or any other contract.
17. Failure by the company to insist upon the strict performance of any terms or conditions herein shall not be deemed a waiver thereof or of any rights the company may have, and shall not be deemed a waiver of any subsequent breach of any term or condition.
18. Where the company has followed a design or instruction furnished or given by the buyer, the buyer shall indemnify the company against all damages, penalties, costs and expenses to which the company may become liable through any work required to be done in accordance with those instructions involving an infringement of a Patent, Trademark, Registered Design, Copyright or Common Law right.
19. All goods distributed and sold by the company are made against a specific company quality specification and are subject to manufacturing tolerances. The company does not warrant that all goods produced will comply exactly with the specification in every respect and the buyer agrees to accept the goods provided that the variations from the specification do not exceed reasonable commercial limits.
20. Water Board requirements are not uniform throughout Australia. We will therefore be unable to accept responsibility for damages or claims resulting from the installation of fittings where the installation does not conform with Water Board requirements.



# retail price catalogue



Protecting the world's most valuable liquid asset... water!



CON-SERV CORPORATION AUSTRALIA PTY. LTD.  
17 Glentanna Street, Kedron · Qld. 4031 Australia  
Phone: +61 (0)7 3630 5744 · Fax: +61 (0)7 3630 5755  
E-mail: [mail@con-serv.com.au](mailto:mail@con-serv.com.au) · [www.con-serv.com.au](http://www.con-serv.com.au)